

**ABBATTITORI/SURGELATORI DI TEMPERATURA
CELLULES DE REFROIDISSEMENT RAPIDE/CELLULES MIXTES
SCHNELLKÜHLER/SCHOCKFROSTER
BLAST CHILLERS/FREEZERS
ABATIDORES/CONGELADORES RAPIDOS DE TEMPERATURA**



**ISTRUZIONI ORIGINALI - MANUALE D'USO E INSTALLAZIONE
INSTRUCTIONS ORIGINALES - MANUEL D'UTILISATION ET D'INSTALLATION
URSPRÜNGLICHE BEDIENUNGSANLEITUNG - BEDIEN- UND INSTALLATIONSHANDBUCH
ORIGINAL INSTRUCTIONS - USE AND INSTALLATION MANUAL
INSTRUCCIONES ORIGINALES - MANUAL DE USO E INSTALACIÓN**



IT

Leggere attentamente le avvertenze contenute nel presente libretto in quanto forniscono importanti indicazioni riguardanti la sicurezza, d'uso e di manutenzione.

Conservare con cura questo libretto per ogni ulteriore consultazione dei vari operatori.

Il costruttore si riserva il diritto di apportare modifiche al presente manuale, senza preavviso e responsabilità alcuna.

FR

Lire avec attention les instructions contenues dans ce livret car elles fournissent d'importants renseignements pour ce qui concerne la sécurité, l'emploi et l'entretien.

Garder avec soin ce livret pour des consultations ultérieures de différents opérateurs.

Le constructeur se réserve le droit d'apporter des modifications à ce manuel, sans préavis ni responsabilité d'aucune sorte.

DE

Lesen Sie bitte aufmerksam diese Gebrauchsanweisung durch, die wichtige Informationen bezüglich der Sicherheit, dem Gebrauch und der Instandhaltung enthält.

Heben Sie sorgfältig diese Gebrauchsanweisung auf, damit verschiedene Anwender sie zu Rat ziehen können.

Der Hersteller behält sich das Recht, Änderungen dieser Gebrauchsanweisung ohne Ankündigung und ohne Übernahme der Verantwortung vornehmen zu können.

GB

Carefully read the instructions contained in the handbook. You may find important safety instructions and recommendations for use and maintenance.

Please retain the handbook for future reference.

The Manufacturer is not liable for any changes to this handbook, which may be altered without prior notice.

ES

Lea atentamente las advertencias contenidas en este manual pues dan importantes indicaciones concernientes la seguridad, la utilización y el mantenimiento del aparato.

Rogamos guarde el folleto de instalación y utilización, para eventuales futuros usuarios.

El constructor se reserva el derecho de hacer modificaciones al actual manual, sin dar algún preaviso y sin responsabilidad alguna.

INDEX

SAFETY WARNINGS AND INFORMATION.....	6
GENERAL INFORMATION	6
PERSONAL PROTECTIVE EQUIPMENT	7
GENERAL SAFETY	8
GENERAL SAFETY RULES.....	8
LOADING AND DISCHARGING OF FOODSTUFFS FROM THE MACHINE	11
CLEANING AND MAINTENANCE OF THE MACHINE.....	11
WARRANTY TERMS AND EXCLUSIONS	14
GENERAL INFORMATION	15
INTRODUCTION	15
ADDITIONAL INSTRUCTIONS	15
INTENDED USE AND RESTRICTIONS	15
EQUIPMENT IDENTIFICATION / NAMEPLATE DATA.....	15
TESTING	16
COPYRIGHTS.....	17
STORING THE MANUAL.....	17
INTENDED AUDIENCE OF THE MANUAL.....	17
DEFINITIONS.....	17
RESPONSIBILITY	18
LIST OF REGULATION REFERENCES	18
NORMAL USE OF THE MACHINE.....	19
CHARACTERISTICS OF PERSONNEL TRAINED IN ROUTINE USE OF THE MACHINE	19
CHARACTERISTICS OF PERSONNEL AUTHORISED TO WORK ON THE MACHINE.....	19
THE OPERATOR IN CHARGE OF ROUTINE USE	19
TRANSPORTATION AND HANDLING.....	19
UNPACKING.....	20
POSITIONING.....	20
DIMENSIONS	21
TECHNICAL DATA	22
ELECTRICAL CONNECTION	23
WATER CONNECTION	24
WATER SUPPLY REQUIREMENTS.....	24
SUGGESTIONS ON FILTRATION SYSTEMS.....	25
WATER CONNECTION.....	26
WARNINGS FOR USE	26
WATER DRAINAGE CONNECTION.....	26
CONTROL AND SAFETY SYSTEMS.....	27
REFRIGERANT MATERIAL SAFETY DATA SHEET	28
DISPOSAL	28
OPERATION.....	30
SETTING UP	30
MACHINE LOADING.....	31
POSITION OF TRAYS	31
CORE PROBE.....	31
TEMPERATURES	32
LENGTH	32
CONTROL PANEL.....	33
ICONS ON THE TOUCH SCREEN.....	34
WARNING ICONS ON THE TOUCH SCREEN	35
MAIN CYCLE ICONS	36
FIRST START-UP	37
LANGUAGE SETTING.....	37

PROGRAMS	38
BLAST-CHILLING	38
AUTOMATIC BLAST-CHILLING	39
BLAST-FREEZING	40
AUTOMATIC BLAST-FREEZING	41
SLOW COOKING	42
THAWING	43
LEAVENING	44
SPECIAL CYCLES	46
BLAST-CHILLING/BLAST-FREEZING CYCLE	48
MODIFY PARAMETERS	50
CYCLE INFO	51
RECIPE SAVING	52
LOW TEMPERATURE COOKING CYCLE	53
DIRECT LEAVENING CYCLE	54
SCHEDULED LEAVENING CYCLE	55
TIMED THAWING CYCLE	56
PROBE THAWING CYCLE	57
SPECIAL CYCLES - I.F.R.	58
SETTINGS	59
SERVICE	59
WATER DATA SETTING	60
HACCP DATA	61
DOWNLOAD HACCP DATA	61
MAINTENANCE	63
ROUTINE MAINTENANCE	63
NEEDLE PROBE CLEANING	64
TRAY HOLDERS AND INNER STRUCTURE	64
DRAIN PLUG	64
OTHER SURFACES	64
CLEANING THE AIR CONDENSER	65
STAINLESS-STEEL MAINTENANCE	65
PRECAUTIONS IN THE CASE OF LONG PERIODS OF INACTIVITY	66
TROUBLESHOOTING	66
ANOMALY TABLES	66
EXTRAORDINARY MAINTENANCE	72
VIDEO BOARD MAINTENANCE CHECKLIST	72
ATOMISER NOZZLE MAINTENANCE	72
MAINTENANCE OF PANEL BOARD	74
UPDATING THE FIRMWARE (SOFTWARE) OF THE ELECTRONIC CIRCUIT BOARDS	75
UPDATE PROCEDURE	75
CONDENSING SYSTEM MAINTENANCE	76
REPLACEMENT CORE PROBE	76
FURTHER INFORMATION	77
ERGONOMIC FEATURES	77
CERTIFICATION	77
GENERAL RECOMMENDATIONS	77
RECOMMENDED HANDLING OF TRAYS ACCORDING TO THEIR WEIGHT	78
ENERGY CONSUMPTION CHART (*)	79
WIRING DIAGRAM PLATE	80

Foreword

Read the following instructions, including the terms of warranty, before installing and using the machine.

The installation, operation and maintenance manual provides users with useful information for using the machine correctly and safely.

The instructions in this manual constitute a series of warnings whose purpose is to guarantee the performance of the machine and to prevent damage to persons, animals and property as a result of incorrect conditions of use.

It is important that all persons involved in the transport, installation, commissioning, use, maintenance, repair and decommissioning of the machine consult and read this manual carefully before proceeding with the various operations, in order to prevent incorrect manoeuvres and mishaps which could jeopardise the integrity of the machine or be hazardous to personal safety. The user should be regularly informed of safety regulations. It is also important to instruct and update the personnel authorised to operate the machine on its use and maintenance.

It is important that the manual always be kept at the disposal of operators and that it be carefully stored at the place of operation of the machine so that it can be easily and immediately accessible for consultation should doubts arise or if circumstances require it.

In the event of any doubts or uncertainties even after consulting the manual regarding use of the equipment, contact the Manufacturer or the Authorised service centre, which will be available to ensure prompt and accurate assistance for better operation and maximum efficiency of the machine. Bear in mind that the regulations in force on safety, hygiene at work and environmental protection must always be observed during operation of the machine. It is the user's responsibility to ensure that the machine is only operated and used under optimum safety conditions for people, animals and property.

IMPORTANT

The manufacturer disclaims all liability for any operation carried out on the equipment disregarding the instructions in this manual.

The manufacturer reserves the right to modify the characteristics of the equipment presented in this publication without prior notice.

Whole or partial reproduction of this manual is prohibited.

The manual is available in electronic format either by contacting the supplier or by contacting customer service or by downloading the latest version from the website.

The manual must always be kept near the machine in an easily accessible place. Operators responsible for use and maintenance of the machine must have it available for consultation at any time.

Annotate the emergency assistance number of specialised maintenance personnel.

Name and Surname	Address	Tel./fax no.

SAFETY WARNINGS AND INFORMATION

GENERAL INFORMATION

It is necessary to be familiar with the terms and conventions used in the manual in order to allow safe use and understanding of the machine.

Below is a list of symbols to identify the various types of warnings and dangers.



WARNING – Danger to the health and safety of persons involved



WARNING – Risk of electric shock – dangerous voltage



CAUTION – Danger of damage to machine or the product being processed



IMPORTANT – Important product information or instructions



Equipotentiality



Read instructions before using the equipment



Insights and explanations

This equipment is intended for use in commercial applications such as restaurant kitchens, canteens, hospitals, public institutions, bakeries, butcher shops, etc. It is not suitable for continuous large-scale food production.

The machine must be used by specialised personnel.

Under supervision or if instructed in safe use and understand the inherent risks, this equipment may be used by children over 8 years of age and by persons with limited physical, sensory or mental capabilities or lack of appropriate knowledge.

Do not allow children to play with the equipment.

Keep packaging materials and cleaning agents out of the reach of children.





Cleaning or maintenance work must not be carried out by children without supervision.

Do not store explosive substances such as pressurised containers with flammable propellant in this equipment.

Do not remove, tamper with or render the machine marking illegible.
 Destroy the marking when scrapping the machine.
 Keep these instructions carefully for reference by the various operators.

PERSONAL PROTECTIVE EQUIPMENT

Summary table of personal protective equipment (PPE) to be used during machine work.

Description	Protective clothing	Safety footwear	Gloves	Goggles	Helmet or hardhat
					
Transport	-	■	□		
Handling	-	■	□		
Packaging removal	-	■	□		
Installation	-	■	■ (1)		
Routine use	■	■	■ (2)		
Adjustments	□	■	-		
Routine cleaning	□	■	■ (1-3)		
Special cleaning	□	■	■ (1-3)		
Maintenance	□	■	□		
Dismantling	□	■	□		
Scrapping	□	■	□		
Key:					
■	PPE REQUIRED				
□	PPE AVAILABLE OR TO BE USED IF NECESSARY				
-	PPE NOT FORESEEN				

(tab 1)

1. Cut-resistant gloves must be worn during these operations. Please note that failure to use personal protective equipment by operators, specialised personnel or others involved in the use of the equipment may result in exposure to health hazards.
2. During this operation, gloves protect hands from cold or hot pans as they are removed from the equipment. Please note that failure to use personal protective equipment by operators, specialised personnel or others involved in the use of the equipment may result in exposure to chemical hazards and cause damage to health.
3. During these operations, gloves must be suitable for contact with the chemicals used (refer to the safety data sheet of the substances used for information on the PPE required). Please note that failure to use personal protective equipment by operators, specialised personnel or others involved in the use of the equipment may result in exposure to chemical hazards and cause possible damage to health.

GENERAL SAFETY

The machines are equipped with electrical and/or mechanical safety devices to protect workers and the machine itself.

Tampering with the machine or having it operate without guards or safety devices is strictly prohibited.

Do not make any modifications to the parts supplied with the equipment.

Please note that the parts of the manual illustrating parts without guards are used to facilitate understanding.

Using the machine without guards or with guards deactivated is prohibited.

Removing, modifying, tampering with or rendering the danger and obligation labels and safety signs on the machine illegible is prohibited.





GENERAL SAFETY RULES

Guards installed on the machine

Safety measures are represented on the machine by:

- Fixed guards (condenser guards, tops, side panels, etc.), fixed to the machine and/or frame with screws or quick-release couplings that can only be removed or opened with tools or instruments. The user is advised not to remove or tamper with these devices. The Manufacturer declines all liability deriving from tampering or non-use.
- Mobile interlocked guards (door) for access to the inside of the machine.
- Access doors to the machine's electrical equipment are made of panels that can be inspected only using tools. Do not open the door while the machine is connected to the power supply.

Safety signs to be displayed on or near the machine:

Prohibited	Meaning
	Do not remove safety devices
	Do not use water to extinguish fires
Danger	Meaning
	Caution: hot surface
	Caution: steam output



Danger of electrocution (displayed on electrical components with indication of voltage)

(tab 2)

Discontinued use

- In case of prolonged non-use of the equipment, it is advisable to render it inoperative by disconnecting the power cable from the mains.

Warnings for use and maintenance

There are mainly mechanical, thermal and electrical hazards on the machine. Wherever possible, the risks have been neutralised:

- Directly by adopting suitable design solutions
- Indirectly by adopting protections and safety devices.
- By signalling any abnormal situations on the display on the door or instrument panel
- During maintenance, however, certain risks remain that cannot be eliminated and must be neutralised by adopting specific behaviour and precautions.
- Carrying out checks, cleaning, repair or maintenance operations on moving parts is prohibited. Operators must be informed of this prohibition by means of clearly visible notices.
- In order to guarantee the efficiency and correct operation of the machine, it is essential to carry out periodic maintenance following the instructions given in this manual.
- It is advisable to periodically check the correct operation of the safety devices and the insulation of the electrical cables. We recommend replacing them if they are damaged.
- Extraordinary maintenance operations on the machine must only be carried out by specialised personnel equipped with all suitable personal protective devices, equipment, tools and aids.
- Removing and/or operating the machine after removing, modifying or tampering with guards, protections or safety devices is always prohibited.

Reasonably foreseeable misuse

Any use other than that specified in this manual is considered incorrect.

Other types of work or activities are not permitted during machine operation that are to be considered as misuse or that may generally lead to safety hazards for operators and damage to equipment. Reasonably foreseeable misuse is considered to be:

- Lack of maintenance, cleaning or periodic checks of the machine;
- Structural modifications or changes to the operating logic;
- Tampering with guards or safety devices;
- Non-use of personal protective equipment by operators, specialised personnel or maintenance staff;
- Failure to use suitable accessories (e.g. use of unsuitable equipment or ladders);
- Storage in the vicinity of the machine of combustible or inflammable materials or in any case materials that are not compatible with or not pertinent to work;
- Incorrect machine installation;
- Introduction of objects into the machine which are not compatible with its use or which may damage the machine, persons or pollute the environment;
- Boarding onto the machine;
- Failure to comply as described in the intended use of the machine;
- Other behaviour which causes risks that cannot be eliminated by the Manufacturer;

The behaviours described above are to be considered prohibited.

Residual risks

- The machine poses risks that it has not been possible to eliminate completely by design or through the installation of suitable protections. Operators have in any case been informed of these risks through this manual, which carefully states which personal protective equipment is present for employees. Sufficient space is provided during installation of the machine to limit these risks.

To preserve these conditions, the areas surrounding the machine must always:

- Be kept free of obstacles (such as ladders, tools, containers, boxes, etc.)
- Be clean and dry;
- Be properly lit.

The residual risks remaining on the machine are listed below for the user's complete information; such behaviour is to be considered incorrect and therefore strictly forbidden.

Residual risk	Description of dangerous situation
Slip or fall	Operators may slip due to the presence of water or dirt on the floor.
Burns/abrasion (e.g. heating elements, cold pan, cooling fins and pipes)	Operators intentionally or unintentionally touch certain components inside the machine without using protective gloves.
Electrocution	Contact with live electrical parts during maintenance operations carried out with the electrical panel live.
Fall from height	Operators work on the machine using unsuitable means of access to the top (e.g. ladders or climbing on top)
Tipping loads	Use of unsuitable attachments or lifting systems or unbalanced loading when handling the machine or the packaging containing the machine.
Chemical (refrigerant fluid)	Inhalation of refrigerant fluid. Therefore always refer to the labels on the equipment
Eye damage, skin damage	Ion exposure for equipment with ionising systems, if the door interlock fails

(tab 3)

Normal use of the machine

- If the equipment includes an ionising system, DO NOT inhale air in the vicinity of the source.
- Should an anomaly occur (short circuit, cables outside the terminal box, motor failure, damage to the cable protection sheaths), the operator must immediately switch off the machine by disconnecting the power supply.

LOADING AND DISCHARGING OF FOODSTUFFS FROM THE MACHINE

- Cover or wrap food before placing it in the machine.
- Wear kitchen gloves when loading and unloading food.
- Please observe the table below for the maximum load for each piece of equipment and shelf:

Model	Maximum blast-chilling load (kg)	Maximum shelf load (kg)
...51H (5L)	20	40
...51M (5L)	25	40
...101L-101S (10L)	50	40
...101S (40kg)	45	40

(tab 4)

CLEANING AND MAINTENANCE OF THE MACHINE

- Before any cleaning or maintenance operation, disconnect the equipment from the electrical mains.
- Do not touch the equipment if your hands and/or feet are wet or if barefoot.
- Do not remove safety guards.

- Use a ladder with a guard-rail when working on equipment with accessibility from above.
- Use suitable personal protective equipment.
- Maintenance and inspection work, as well as machine overhauls, must only be carried out by specialised personnel or by customer service equipped with suitable personal protective equipment, tools and aids.
- Work on electrical equipment may only be carried out by specialised personnel or by customer service.
- The machine must be set in safe conditions before any maintenance work is started.
- Observe the expertise required for the various routine and extraordinary maintenance operations.

Failure to observe the warnings may result in risks to personnel.

Routine maintenance

Switch off the power supply to the machine before cleaning the equipment.

The machine must not be cleaned with water jets or steam cleaners.

Cleaning the machine and accessories

- Pay attention to the choice and use of cleaning agents in order to maintain proper performance and safety of the equipment.
- Before use, clean all internal parts and accessories with lukewarm water and neutral soap or with products that are more than 90% biodegradable (in order to reduce the emission of pollutants into the environment), then rinse and dry thoroughly. Where possible, use the dishwasher for cleaning.
- Do not use detergents containing chlorine, solvent-based detergents (such as trichloroethylene etc.), powders or abrasive agents, scouring pads or sponges to clean the equipment, as these may damage the surfaces. Avoid the use of organic solvent substances or essential oils. These substances could affect the synthetic elements of the equipment.
- Do not use products (even if diluted) containing chlorine (sodium hypochlorite, hydrochloric acid, muriatic acid, etc.) to clean the flooring under equipment.
- Take particular care when using the needle probe, bearing in mind that it is a sharp object that must be handled with particular care when cleaning.

Preventive maintenance

- In order to ensure machine safety and performance, it is advisable to have maintenance operations carried out by Angelo Po specialised personnel every 12 months, in accordance with the Angelo Po service manuals. For further details, please contact your local Angelo Po Service Centre.

Repairs and extraordinary maintenance

- Repairs and extraordinary maintenance must only be carried out by specialised and authorised personnel. The manufacturer declines all liability for any failure or damage caused by the intervention of technicians not authorised by the manufacturer and the local original manufacturer's warranty.

Spare parts and accessories

- Only use original accessories and/or spare parts. The use of non-original accessories and/or spare parts will invalidate the manufacturer's warranty and may render the machine non-compliant with safety standards.

Maintenance intervals

- Maintenance intervals depend on the actual operating conditions of the machine and the environmental conditions (presence of dust, humidity, etc.), so no definite time intervals can be given. However, it is advisable to carry out scrupulous and regular machine maintenance in order to keep service interruptions to a minimum.

Maintenance, inspections, checks and cleaning	Frequency	Responsible
Routine cleaning • General cleaning of the machine and surrounding area	Daily	Operator
Mechanical protective devices • Check the conditions and verify that there are no deformations, loosening or removals	Every 6 months	Service
Control • Check that there are no cracks or deformations, tightening of screws on the mechanical part: check the legibility and condition of inscriptions, stickers and symbols and restore them if necessary	Annual	Service
Machine structure • Tightening of main bolts (screws, fastening systems, etc.) on machine	Annual	Service
Safety signs • Check legibility and conditions of safety signs	Annual	Service
Electrical control panel • Check the conditions of the electrical components installed inside the electrical control panel. Check the wiring between the electrical control panel and the machine parts.	Annual	Service
Electrical connection cable • Check the conditions of the connection cable (replace if necessary)	Annual	Service
General overhaul of the machine • Check all components, electrical equipment, corrosion, piping etc.	Every 10 years ⁽¹⁾	Service

tab 5

(1) - the machine has been built and designed to last for approximately 10 years. After this period (from commissioning) a general overhaul of the machine should be carried out.

- It is advisable to enter into a preventive and scheduled maintenance contract with Customer Service.

WARRANTY TERMS AND EXCLUSIONS

If the purchase of this equipment includes warranty coverage, it is provided in accordance with local regulations and on the condition that the product is installed and used for the purposes intended and described in the corresponding equipment documentation.

The warranty is applicable if the user has used only original spare parts and has performed maintenance in accordance with Angelo PO maintenance and user documentation made available in hard copy or electronic format.

Angelo Po recommends the use of Angelo Po approved detergents, rinsing agents and descaling agents to achieve optimum results and to maintain the efficiency of the product over time.

The Angelo Po warranty does not cover:

- Costs of service trips for delivery and collection of the product;
- Installation;
- Training on how to use/operate the product;
- Replacement (and/or supply) of damaged parts subject to wear and tear, unless this is due to defects in material or workmanship reported within one week of failure;
- Correction of external wiring;
- Correction of unauthorised repairs as well as any damage, faults or inefficiencies caused by and/or resulting from:
 - Insufficient capacity and/or faults in electrical installations (current/voltage/frequency, including spikes and/or interruptions);
 - Inadequate or interrupted water, steam, air, gas supply (including impurities and/or other factors not in accordance with the technical requirements of each machine);
 - Consumable hydraulic parts, components or cleaning products not approved by the manufacturer;
 - Negligence, misuse, abuse and/or non-compliance by the user with the operating and care instructions described in the equipment documentation;
 - Improper or poor installation, repair, maintenance (including tampering, modifications and repairs carried out by unauthorised third parties) and modification of safety systems;
 - Use of non-original components;
 - Environmental conditions that cause thermal stress (e.g. overheating (chilling) or chemical stress (e.g. oxidation/corrosion));
 - Foreign objects placed on or attached to the product;
 - Accidents or force majeure;
 - Transport and handling, including scratches, dents, chips, and/or other damage to the finish of the product, unless such damage results from defects in material or workmanship and is reported within one week after delivery unless otherwise agreed upon;
 - Replacement of lamps, filters or any consumable parts;
 - Any accessories or software not approved or specified by Angelo Po;

The warranty does not include scheduled maintenance (including parts required to perform such maintenance) or the supply of cleaning agents, unless this is expressly covered by a local agreement in accordance with local conditions.

GENERAL INFORMATION



WARNING

Refer to the chapter “Safety warnings and information”.

INTRODUCTION

The following provides information on the intended use of this equipment, its testing, and describes the symbols used (which mark and allow you to recognise the type of warning), definitions of terms used in the manual, and a range of useful information for equipment users.

ADDITIONAL INSTRUCTIONS

Please note that the drawings and diagrams in the manual are not to scale. They serve to supplement the written information and act as a summary to it but are not intended as a detailed representation of the machine supplied.
The numerical values represented in the equipment installation diagrams are expressed in millimetres or inches.

INTENDED USE AND RESTRICTIONS

This machine is designed for quick blast-chilling, food preservation (quickly lowering the temperature of cooked food to preserve its initial qualities and ensure its shelf life for several days), cooking, leavening and thawing of food.
Any other use is to be considered improper.



CAUTION

The machine is not suitable for installation outdoors and/or in environments subject to weathering (rain, sun, etc.).



NOTE

The manufacturer accepts no liability for improper use of the machine

EQUIPMENT IDENTIFICATION / NAMEPLATE DATA

Make sure the technical wiring specifications comply with the ratings (i.e., V, kW, Hz, no. phases and mains power).
Please quote the product's serial number (shown on the rating plate) on any enquiry to the Manufacturer.

①				②				③				④				⑤				Ⓡ		⑦	
Ⓐ ~ Ⓑ				Ⓒ				Ⓓ				Ⓔ				Ⓕ				Ⓖ		Ⓗ	
Ⓐ ~ Ⓑ				Ⓒ				Ⓓ				Ⓔ				Ⓕ				Ⓖ		Ⓗ	
~				Ⓜ				Ⓝ				Ⓓ				Ⓕ				Ⓖ		Ⓗ	

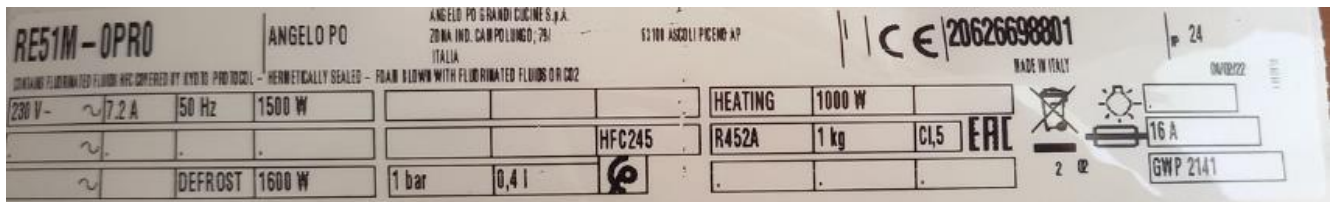

List of rates shown on the rating plate:

- | | |
|---|--|
| <ul style="list-style-type: none"> 1) Model 2) Manufacturer's name and address 3) CE mark 4) Year of make 5) Serial number 6) Power insulation class 7) Electrical device casing protection rating A) Input voltage B) Electric current intensity C) Frequency D) Rated power E) Total lamp power | <ul style="list-style-type: none"> F) Fuse current G) Coolant type H) Coolant q.ty L) Temperature grade M) Max hydraulic supply pressure N) Cabinet temperature P) Expanding fluid R) WEEE Symbol S) Heater presence T) Heater power W) Heating element power Z) Minimum pressure AA) Water consumption |
|---|--|

TESTING

Our equipment is designed and verified through laboratory tests to ensure guaranteed performance and efficiency.

The equipment is delivered to be ready for use.

Passing the tests (visual test, electrical test, functional test) is guaranteed by means of the specific annexes.

Should the appliance have been transported horizontally instead of a vertical position **DO NOT START THE APPLIANCE IMMEDIATELY. WAIT FOR AT LEAST 24 HOURS BEFORE OPERATING. *The manufacturer declines any responsibility and any warranty obligation if damage occurs to the equipment imputable to transportation in a horizontal position.***

Respect the machine's operating conditions: outside temperatures must be between 15°C and 40°C.

Switch on the unit and wait 30 minutes before use if the outside temperature is "low".

Check absorption

Carry out at least one complete blast-chilling cycle in order to verify correct operation

Make sure that the room has proper air exchange.

Model	Air quantity [m ³ /h]
51L-51H	1100
101L-101S	3500

(tab 6)

COPYRIGHTS

This manual is intended exclusively for consultation by operators and may only be handed over to third parties with the permission of the company Angelo PO.

STORING THE MANUAL

The manual must be kept intact for the entire life of the machine up to its demolition. If the machine is transferred, sold, hired, leased or rented out, the manual must accompany the machine itself.

INTENDED AUDIENCE OF THE MANUAL

The manual is intended for:

- The transporter and handling personnel;
- Installation and commissioning personnel;
- The employer of the machine users and the person in charge of the workplace;
- The operators assigned to use the machine;
- Specialised personnel – Customer Service

DEFINITIONS

Definitions of the main terms used in the manual are listed below. Careful reading is recommended before use.

Operator	Person responsible for installing, adjusting, using, maintaining, cleaning, repairing and transporting the machine.
Manufacturer	Angelo Po or any other service centre authorised by Angelo Po.
Ordinary machine operator	Operator who has been informed, trained and instructed about the tasks to be carried out and the risks involved in ordinary use of the machine.
Customer service or specialised personnel	An operator instructed/trained by the Manufacturer who, on the basis of his/her professional training, experience, specific training, knowledge of accident prevention regulations, is able to assess the work to be carried out on the machine and recognise and avoid risks. His/her professionalism covers the fields of mechanics, electrical engineering, electronics, etc.
Hazard	Source of possible injury or damage to health.
Hazardous situation	Any condition in which an Operator is exposed to one or more hazards.
Risk	Combination of probability and severity with possible injury or damage to health in a hazardous situation.
Protections	Safety measures consisting of the use of specific technical means (guards and safety devices) to protect Operators from Hazards.
Guard	An element of a machine used specifically to provide protection by means of a physical barrier.
Safety device	Device (other than a Guard) that eliminates or reduces a Risk; it may be used alone or be combined with a Guard.

User	The person who has purchased the machine and/or who operates and uses it (e.g. company, contractor, business).
Electrocution	Accidental discharge of electric current onto the human body.

(tab 7)

RESPONSIBILITY

No liability is accepted for damage or malfunctions caused by:

- Failure to comply with the instructions given in this manual;
- Repairs carried out incorrectly and replacement of spare parts other than those specified in the spare parts catalogue (the assembly and use of non-original spare parts and accessories may adversely affect operation of the machine and invalidate the original manufacturer's warranty);
- Operations carried out by non-specialised personnel;
- Unauthorised modifications or interventions;
- Lack of or inadequate maintenance;
- Improper use of the machine;
- Unforeseeable exceptional events;
- Use of the machine by uninformed and/or untrained personnel;
- Failure to apply the provisions in force in the country of use regarding safety, hygiene and health in the workplace.

No liability is accepted for damage caused by arbitrary conversions and modifications by the user.

Responsibility for the identification and selection of appropriate, suitable personal protective equipment, to be worn by the operators, is the responsibility of the employer or the person in charge of the workplace or the service technician, in accordance with the regulations in force in the country of use.

The manufacturer declines all liability for inaccuracies in the manual if they are attributable to printing or translation errors.

Any additions to the installation, operation and maintenance manual which the Manufacturer deems appropriate to send to the user must be kept together with the manual, of which they will form an integral part.

LIST OF REGULATION REFERENCES

The cooling cabinet we manufacture fully complies with the following European and national regulations:

2006/42/EC (machine regulations)
 2004/30/EU (EMC regulation)
 2014/68/EU (PED regulation)
 2011/65 (RoHS2 regulation)
 2015/1094/EU (Energy labelling)
 2015/1095/EU (Ecodesign)
 658/88 CEE
 108/89 CEE
 DPR 327/80 art.31 (Italy)

D.M. 15-06-71 (Italy)
 D.L. n°110 27-01-92 (Italy)
 J.O. 16-07-74 n°74-163 (France)

and the following European regulations:
 EN55014-1;EN55104-2
 EN61000-3-2 ; EN61000-3-3
 EN60335-1;EN60335-2-89
 EN378-I-II
 EN22042

NORMAL USE OF THE MACHINE



WARNING

Refer to the chapter “Safety warnings and information”

CHARACTERISTICS OF PERSONNEL TRAINED IN ROUTINE USE OF THE MACHINE

The user must make sure that those assigned to routine use of the machine are suitably trained and demonstrate competence in carrying out their tasks, taking care of their own safety and that of third parties.

The user must check that personnel has understood the instructions they have received, in particular those concerning aspects of safety and hygiene in the workplace when using the machine.

CHARACTERISTICS OF PERSONNEL AUTHORISED TO WORK ON THE MACHINE

It is the user's responsibility to check that the persons assigned to the various tasks have the following requisites:

- Have read and understood the manual;
- Training and instruction appropriate to their tasks in order to perform them safely;
- Specific training for correct use of the machine.

THE OPERATOR IN CHARGE OF ROUTINE USE

Must have at least:

- Knowledge of technology and specific experience of operating the machine;
- Basic general and technical knowledge at a level sufficient to read and understand the contents of the manual, including the correct interpretation of signs, drawings and pictograms;
- Sufficient knowledge to safely carry out the tasks for which he/she is responsible as specified in the manual;
- Knowledge of occupational health and safety regulations.

Should any substantial anomaly occur (e.g. short circuits, evidence of cables outside the electrical panels, motor failure, deterioration of the protective sheaths of electrical cables, etc.), the operator in charge of routine use of the machine must:

- Switch off the machine immediately.

TRANSPORTATION AND HANDLING

For transportation and handling, all precautions necessary must be taken in order not to damage the equipment, referring to the indications found on the packaging of the same. Make sure that the consignment has not been tampered with or damaged during transport.

UNPACKING

Installation must be carried out by authorised and specialised personnel.

After removing the packaging, ensure the integrity of the equipment and verify that all the parts or components are present and that the characteristics and state correspond to the specifications of the your order.

If not, please inform the retailer immediately.

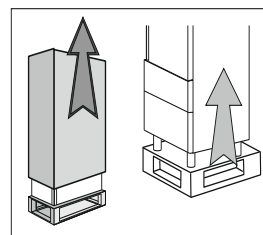

Remove pvc protective film from all over the appliance.

Attention: all the packing material must be disposed of in accordance with the prevailing regulations in the country where the equipment is used and in any case must not be dispersed into the environment.

POSITIONING

The appliance must be installed and tested in full compliance with accident-prevention regulations contained in national law and current guidelines. Installers are to comply with any current local regulations.

- Place the appliance onto the required working site.

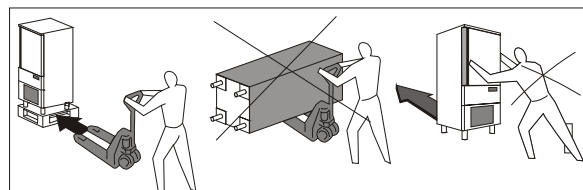

- Avoid locations with exposure to direct sunlight.
- Do not place the appliance in hot, poorly-ventilated rooms.
- Do not place the refrigerated compartment near heat sources.

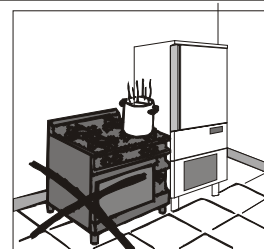

- Leave a min. 100-mm clearance around the appliance on the sides where air inlet and outlet are located.

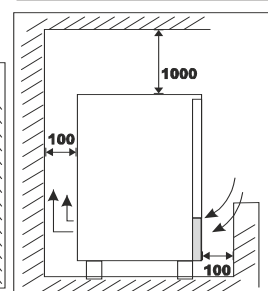
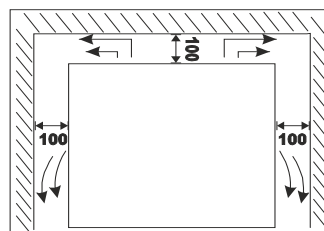

- Level the appliance by means of adjustable feet.

WARNING: If the appliance is not properly levelled the performance and condensate drain may be hampered.

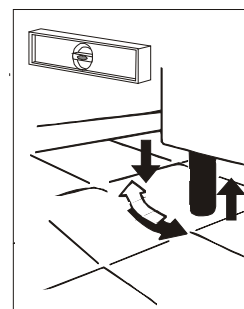

DIMENSIONS

Please refer to the dimensions of your own appliance.

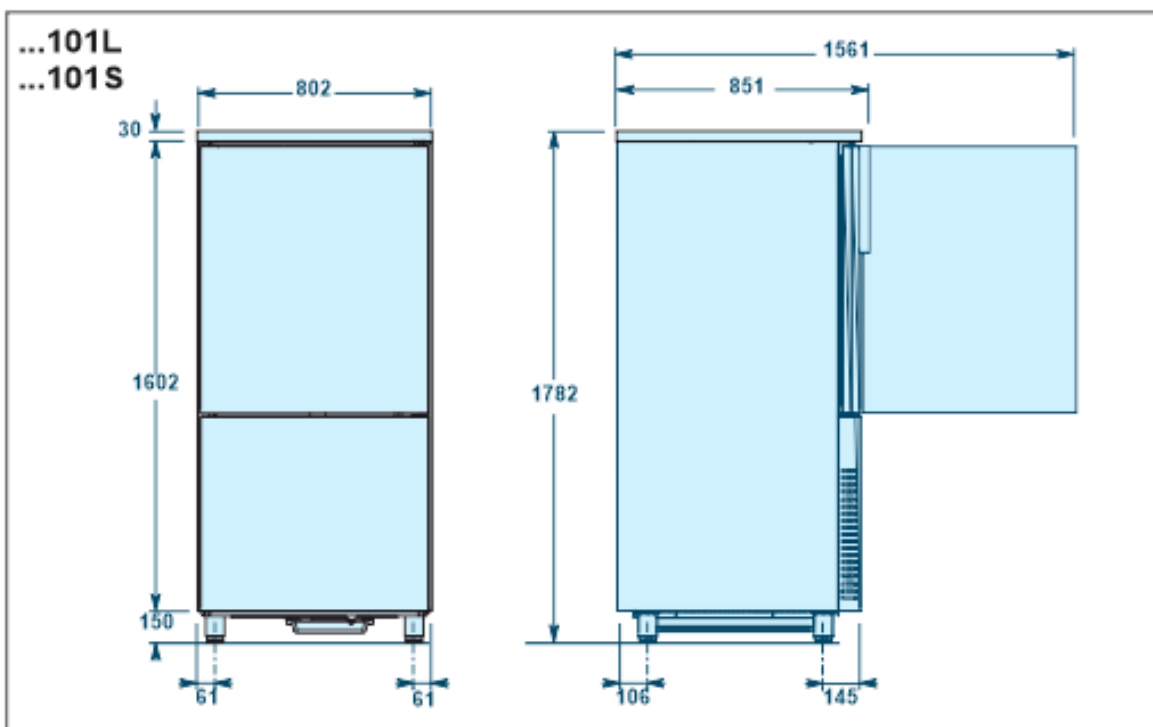
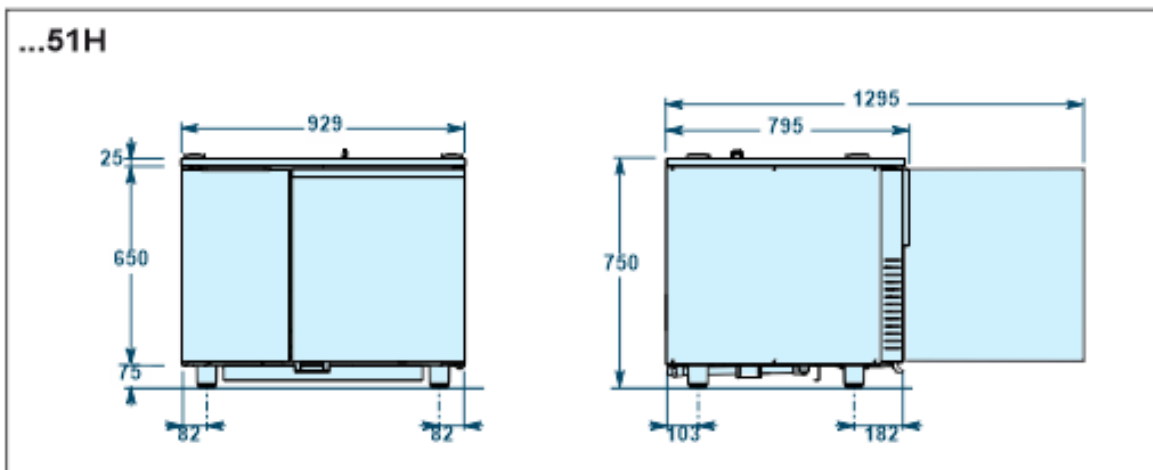
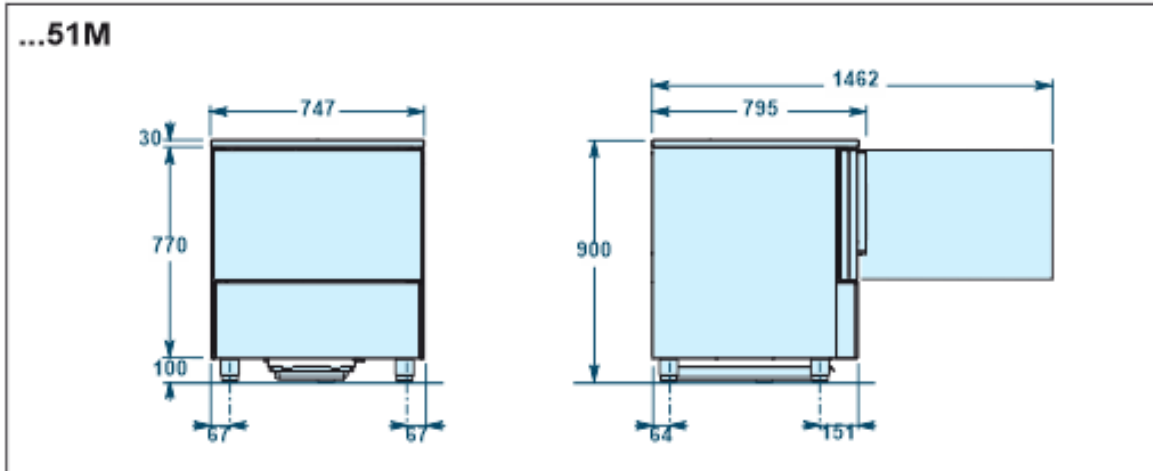

TECHNICAL DATA

Please refer to the technical data of your own appliance.

Model	...51H	...51M	...101L	...101S
Gross weight	135	130	225	225
Net weight	120	120	200	200
Dimensions	929x795x750	747x795x900	802x851x1782	802x851x1782
Capacity				
Mass /cycle [kg] (+90°C ÷ +3°C)	20	25	50	50
Mass /cycle [kg] (+90°C ÷ -18°C)	10	15	25	25
Internal volume [l]	90	90	195	195
Rails	GN1/1 600x400	GN1/1 600x400	GN1/1 600x400	GN1/1 600x400
Trays	6	5	10	10
Power supply				
Voltage [V]	230V 1N~	230V 1N~	400V 3N~	400V 3N~
Frequency [Hz]	50	50	50	50
Intensity [A]	6.7	7.2	6.5	6.5
Power input [W]	1500	1600	4500	4500
Refrigerating unit				
Refrigerating power [W]	825 (A)	1233 (A)	2526 (B)	2526 (B)
Evaporation temperature [°C]	-23.3	-23.3	-25	-25
Cooling temperature [°C]	+90÷+3	+90÷+3	+90÷+3	+90÷+3
Cooling time [min]	90	90	90	90
Freezing temperature [°C]	+90÷-18	+90÷-18	+90÷-18	+90÷-18
Freezing time [min]	240	240	240	240
Condensation temperature [°C]	+54.5	+54.5	+54.5	+54.5
Max room temperature [°C]	+32	+32	+32	+32
Compressor type	Ermetic	Ermetic	Ermetic	Ermetic
Coolant	R452A	R452A	R452A	R452A
Coolant qty [g]	800	1000	1500	1500
Condensation air	Air	Air	Air	Air
Noise [dB] (A)	65	65	72	72
Heating				
Electrical power [W]	1000	1000	2000	2000
Water intake				
Flow rate [l/h]	0.4	0.4	0.4	0.4
IFR	•	•	•	•
Multi-detector probe Pt1000(Ω)	•	•	•	•

(A) – Ashrae conditions

(B) – Cecomaf conditions

ELECTRICAL CONNECTION

The electrical connection and connection systems of the unit must comply with the regulations in force in the country of installation and must be carried out by qualified personnel authorised by the manufacturer.

CAUTION: do not use adapters or extension cords for connection to the mains.

DO NOT USE ADAPTER PLUGS. Due to safety hazards that may arise in certain situations, the use of adapter plugs is strongly discouraged.

DO NOT USE EXTENSION CORDS. The manufacturer does not guarantee the unit if an extension cord is used.

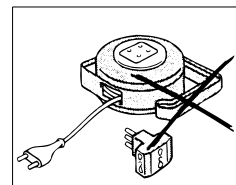

WARNING: any damaged power cord must be replaced by the manufacturer, after-sales service, or qualified personnel to prevent risks.

Check that the mains voltage corresponds to the voltage stated on the technical rating plate of the unit.

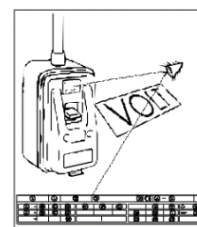

CAUTION: The unit must be connected to an effective earthing system .

CAUTION: It is compulsory to insert the unit into an equipotential system according to the regulations in force. The connection must be made between the different units via the equipotential terminal .

CAUTION: An omnipolar switch is to be installed before the appliance, in compliance with the current regulations applied in the country where the appliance is installed.

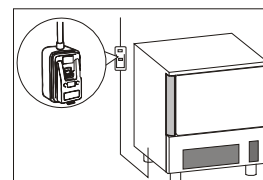

The electrical mains cables must be correctly sized and selected based on the installation conditions.

The electrical connection is carried out from the rear part.

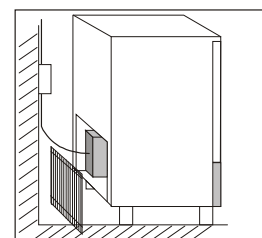

Models 51M-51H have 3m of three-pin cable (3G 1.5mm²) with a SHUKO type plug. Use of any other type of electrical connection or modifying the size of the cable by less than its length is not permitted. Take care to replace it, if necessary, with one having identical characteristics to the original.

Models 101L-101S are provided with 3.5m of pentapolar cable for three-phase power supply (5G 2.5mm²) without a plug.

Fit an electrical plug (not supplied) of a type and capacity suitable for the maximum current absorbed by the unit or make a direct connection to an electrical panel.

The guarantee will cease and the Manufacturer will not be liable for any damage to appliances or operators arising from the non-compliance with the and tamperings to any part of the appliance (electric, thermodynamic or hydraulic plant).

WATER CONNECTION

The water supply connection and connection systems must comply with the regulations in force in the country of installation and must be carried out by qualified personnel authorised by the manufacturer.

WATER SUPPLY REQUIREMENTS

CAUTION: The equipment must be supplied with potable water with the characteristics indicated in the table.

<i>Parameters to check</i>		<i>Value</i>
Pressure		100-400 kPa (1- 4 bar) (*)
Instantaneous water flow rate (l/h)		0.1 l/h
pH		7-8.5
TDS		40-150 ppm
Hardness		3-÷9°f (1.5-5°d, 2.1-6.3°e, 30-90 ppm)
Langelier Index (recommended) (**)		>0.5
Content of salts and metal ions		
Required	Chlorine	<0.1 mg/l
	Chlorides	< 10 mg/l
	Sulphates	< 30 mg/l
Recommended (**)	Iron	< 0.1 mg/l
	Manganese	< 0.05 mg/l
	Copper	< 0.05 mg/l

(tab 8)

(*) *The value refers to the amount of water required to produce steam inside the cabinet.*

(**) *Values differing from these parameters can cause corrosion if combined with incorrect use and environment.*

CAUTION: It is the responsibility of the operator/contractor/owner of the unit to check that the water supplied, whether or not it is treated upstream of the connection and is within the standard values given in this document. Failure to comply with these values may result in damage to the unit and invalidate the manufacturer's warranty for damaged parts.

CAUTION: If the blast-chiller feed water does not comply with the characteristics listed in the above table, a suitable treatment system must be installed before the equipment is put into operation.

CAUTION: If the equipment is operated with feed water that does not have the characteristics listed in the above table, malfunctions and damage may occur for which the Manufacturer accepts no liability.

CAUTION: The Manufacturer's warranty on parts damaged by a water supply that does not correspond to the characteristics listed in the above table may be invalidated.

SUGGESTIONS ON FILTRATION SYSTEMS
--

In the event that the water parameters do not comply with the characteristics in the previous table, you can use the suggestions below when choosing the filtration system to be installed, depending on the parameter that needs to be corrected. These suggestions should then be considered as indicative of certain situations and not exhaustive of all cases that may arise. However, it is always the responsibility of the Owner of the equipment to ensure that the feed water corresponds to the parameters required in the table above, even after installation of the treatment system.

It is advisable to contact personnel or companies specialised in water analysis and treatment to ensure that the feed water meets the required characteristics.

The parameters that are best treated by the corresponding system are then marked in bold in the table.

<i>Parameters</i>	<i>Measured value</i>	<i>Suggested type of treatment</i>
Carbonate hardness Chlorine Chlorides Sulphates	>9°f <0.1 ppm <10 ppm <30 ppm	Softening
Carbonate hardness Chlorine Chlorides Sulphates	<9°f 0.1 - 1 ppm <10 ppm <30 ppm	Activated carbon filter
Carbonate hardness Chlorine Chlorides Sulphates	>3°f <1 ppm 10 - 100 ppm 30 - 100 ppm	Special resin filter or reverse osmosis treatment
Carbonate hardness Chlorine Chlorides Sulphates	>3°f <10 ppm >100 ppm >100 ppm	Reverse osmosis

(tab 9)

WATER CONNECTION

CAUTION: Make the connection in compliance with the relevant laws in force, using the appropriate and prescribed material.

Connect the mains pipe with the connection pipe to the equipment, interposing a stopcock to interrupt the water supply when necessary.

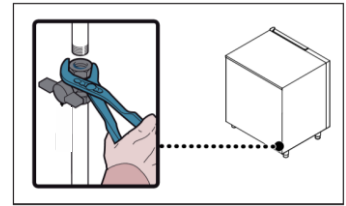

CAUTION: If chemicals are used in the water supply system for sanitation, such as chloramines or sodium hypochlorite, a filter must be installed to ensure their removal.

CAUTION: Check pipes and fittings for corroded parts, as they may contaminate the water inside the unit.

WARNINGS FOR USE

CAUTION: In order to maintain the hygienic characteristics and integrity of the stainless steel (necessary for corrosion protection) over time, it is necessary to wash the inside cabinet daily (see paragraph “CLEANING AND MAINTENANCE”) with suitable cleaning products, drying it completely before use.

CAUTION: Perform maintenance on the water treatment system (if installed) to ensure its proper operation.

CAUTION: Make sure to use new and fully functional accessories.

CAUTION: Use only detergents, chemicals and cleaning procedures appropriate for the unit.

WATER DRAINAGE CONNECTION

The units are equipped with a tray with a special device for collecting condensate on the bottom of the machine.

The tray is extractable from the front part of the unit.

Weekly cleaning/maintenance is recommended in order to avoid the formation of bad smells.

CONTROL AND SAFETY SYSTEMS

The following information concerns skilled staff only.

- **Door micro-switch:** Prevents the appliance from working when the door is open
- **Overall protection fuses:** Protect the whole power circuit from and short-circuits and overloads
- **Compressor thermal relay:** Operates in case of an overload or working failures
- **Bimetallic safety thermostat:** intervenes in the event of excessively high temperature in the inside compartment.
- **Fan Motor Protector:** intervenes in the event of overload or malfunction.
- **Safety pressure-switch:** Operates in case of coolant over-pressure
- **Cabinet temperature control:** Is run by NTC probe through the relevant electronic card
- **Core temperature control:** Is run by PT100 probe through an electronic card
- **Electronic boards:** based on the parameters entered they command and control any devices connected to the equipment.

REFRIGERANT MATERIAL SAFETY DATA SHEET

R452A: fluid components

- pentafluoroethane (HFC 125) 59%
- tetrafluoropropene (HFC 1234yf) 30%
- difluoromethane (HFC 32) 11%

GWP = 2141

ODP = 0

1) Hazard identification

Overexposure through inhalation may cause anaesthetic effects. Acute overexposure may cause cardiac rhythm disorders and sudden death. Product mists or sprays may cause ice burns of eyes and skin.

2) First aid procedures

- Inhalation: keep injured person away from exposure, warm and relaxed. Use oxygen, if necessary. Give artificial respiration if respiration has stopped or is about to stop. In case of cardiac arrest give external cardiac massage. Seek immediate medical attention
- Skin: use water to remove ice from affected areas. Remove contaminated clothes. CAUTION: clothes may adhere to skin in case of ice burns. In case of contact with skin, wash with copious quantities of lukewarm water. In case of symptoms (irritation or blisters) seek medical attention.
- Eyes: immediately wash with ocular solution or fresh water, keeping eyelids open for at least 10 minutes. Seek medical attention.
- Ingestion: it can cause vomit. If conscious, rinse mouth with water and drink 200-300 ml of water. Seek medical attention
- Other medical treatment: symptomatic treatment and support therapy when indicated. Do not administer adrenaline or sympatheticomimetic drugs after exposure, due to the risk of arrhythmia and possible cardiac arrest.

3) Environmental data

Persistence and degradation

- *HFC 143a*: slow decomposition in lower atmosphere (troposphere). Duration in atmosphere is 55 years.
- *HFC 125*: slow decomposition in lower atmosphere (troposphere). Duration in atmosphere is 40 years.
- *HFC 134a*: relatively rapid decomposition in lower atmosphere (troposphere). Duration in atmosphere is 15.6 years
- *HFC 143a, 125, 134a*: does not affect photochemical smog (not included in volatile organic components – VOC – as established in the UNECE agreement). Does not cause ozone rarefaction.

Product exhausts released in the atmosphere do not cause long-term water contamination.

DISPOSAL

WASTE STORAGE

At the end of the product life, avoid release to the environment. The doors should be removed before disposal. Temporary storage of special waste is permitted while waiting for

disposal by treatment and/or final collection. Dispose of special waste in accordance with the laws in force with regard to protection of the environment in the country of the user.

PROCEDURE FOR ROUGH DISMANTLING THE APPLIANCE

All countries have different legislation; provision laid down by the laws and the authorised bodies of the countries where the demolition takes place are therefore to be observed. A general rule is to deliver the appliance to specialised collection and demolition centres. Dismantle the refrigerator grouping together the components according to their chemical nature. The compressor contains lubricating oil and refrigerant, which may be recycled. The refrigerator components are considered special waste, which can be assimilated with domestic waste. Make the appliance totally unusable by removing the power cable and any door locking mechanisms in order to avoid the risk of anyone being trapped inside.

DISMANTLING OPERATIONS SHOULD BE CARRIED OUT BY QUALIFIED PERSONNEL.

THE SAFE DISPOSAL OF WASTE FROM ELECTRICAL AND ELECTRONIC EQUIPMENT (WEEE DIRECTIVE 2002/96/EC)

Do not dump pollutant material in the environment. Dispose of it in compliance with the relevant laws.

Under the WEEE (Waste Electrical and Electronic Equipment) Directive 2002/96/EC, when scrapping equipment the user must dispose of it at the specific authorised disposal centres, or consign it, still installed, to the original seller on purchase of new equipment. All equipment which must be disposed of in accordance with the WEEE Directive

2002/96/EC is marked with a special symbol .

The improper disposal of Waste Electrical and Electronic Equipment is liable to punishment under the relevant laws in the countries where the offence is committed.

Waste electrical and Electronic Equipment may contain hazardous substances with potential harmful effects on the environment and human health. You are urged to dispose of them properly.

OPERATION

SETTING UP

Before setting to operation thoroughly clean the cooling cabinet with a suitable detergent or sodium bycarb dissolved in lukewarm water. Clean the appliance inside to remove any condensate caused by the Manufacturer's final testing.

- a) Cooling and freezing speed depends on the following factors:
- b) container shape, type and material;
- c) whether container lids are used;
- d) foodstuff features (density, water contents, fat contents);
- e) starting temperature;
- f) thermal conduction inside the foodstuffs

Positive /Negative quick cooling time depends on type of foodstuffs to be processed.

In general the programmes the machine is equipped with are based on the chamber temperature management, the fan speed and the chilling time, in any case never exceed 5kg of load (for GN1/1, EN1/1 or 60x40 pans) or 10kg of load (for GN2/1, EN2/1 or 60x80 pans) and a thickness of 50mm in negative chilling phase and 80mm in positive chilling phase (tab.10).

We recommend pre-chilling the work chamber before beginning with a chilling programme and not covering the food during the programme in order not to increase times.

We recommend using the core probe in order to have the exact core temperature reading. Do not stop the cycle before reaching a temperature of +3°C during positive quick cooling and -18°C during negative quick cooling.

Model	Max. output/cycle		Capacity			h mm
	+90[°C]÷+3[°C]	+90[°C]÷-18[°C]	max no.	GN	EN	
...51H	20[kg]	10[kg]	5	1/1	600X400	40
...51M	25[kg]	15[kg]	5	1/1	600X400	40
...101L – ...101S	50[kg]	25[kg]	10	1/1	600X400	40

(tab 10)

MACHINE LOADING

Do not pile up foodstuffs to be cooled. Thickness should be lower than 50mm in negative quick cooling and lower than 80mm in positive quick cooling.

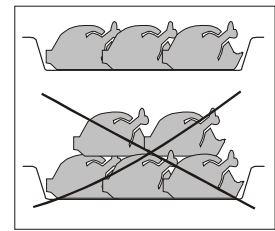

Make sure air circulation is not hampered between food trays.

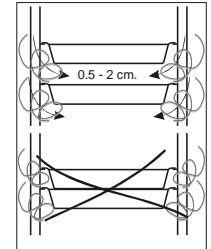

The grid-holding frame (included in those models which include trolleys) is to be located at the centre of the cabinet.

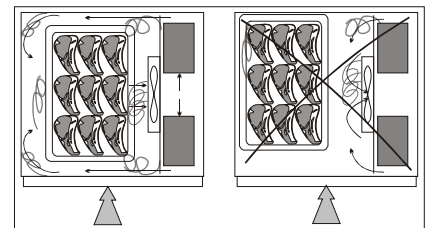

POSITION OF TRAYS

Place the trays as close to the evaporator as possible.

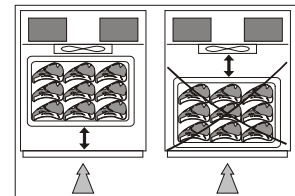

If the cabinet is not full place the trays at equal distance from one another.

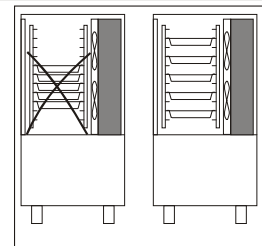

CORE PROBE

The controller guarantees the correct positioning of the probe thanks to a special algorithm that detects the core of the product.



TEMPERATURES

Avoid leaving cooked products at room temperature.

It is advisable to start the blast-chilling/blast-freezing program as soon as the preparation or cooking phase has ended, taking care to place the product in the unit at a temperature no lower than +70°C. You can place the cooked product in the unit even at very high temperatures, above +100°C, as long as the cabinet has been pre-cooled.

LENGTH

Cooled or frozen processed foodstuffs may be stored in a refrigerator for 5 days of processing with no quality alterations.

For best results we recommend keeping temperature constant throughout the storing (0°C to 4°C), according to the various commodities.

Storing time may be increased to approx. two weeks by using vacuum processing.

After a negative quick cooling cycle, foodstuffs may be stored safely for 3 to 18 months, according to the type of foodstuff processed.

We strongly recommend keeping storing temperature at -20°C or below.

The cooled product should be wrapped in a specific film for foodstuffs (better still, vacuum stored) and provided with a sticker reporting the content [A], date of processing [B] and expiry date [C] written in permanent type ink.

CONTROL PANEL

Allows the core temperature of the product to quickly reach +3°C, reduces the natural evaporation of the food, retains humidity and prevents bacterial growth after cooking. The blast-chilling function lets you plan preparations in advance, increase productivity, preserve the taste, colour, aroma and weight and eliminate the risk of poisoning and waste. All organoleptic characteristics are maintained thanks to perfect air and temperature control.

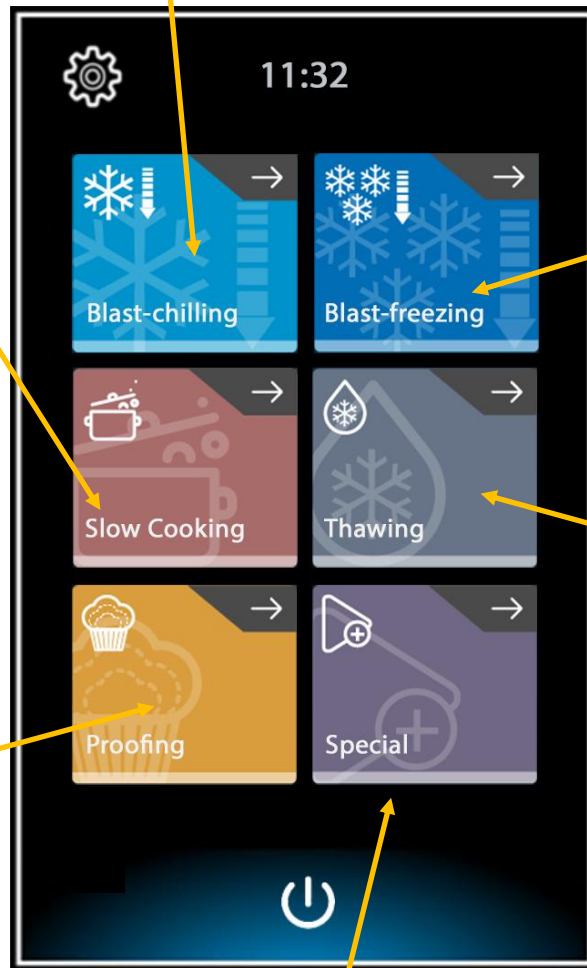

Low temperature cooking allows food to be cooked at up to 85°C while respecting its nutritional properties and keeping it juicier thanks to a gentle cooking process.

During normal freezing, the liquids in food solidify, forming macro-crystals that damage the structure. ARIO blast-freezing brings the core of the food to -18°C very quickly but with the formation of microcrystals that preserve the organoleptic characteristics.

Allows leavening while controlling temperatures. Limits over-drying and guarantees an optimal level of hydration at all times. It is possible to choose between direct and scheduled leavening: the phases of scheduled leavening are cooling – preserving – reactivation – leavening – holding. Always with careful humidity control.

It lets you choose the temperature, ventilation and thawing time of food before use. This process takes place in such a way that microcrystalline water is slowly reabsorbed into the food. This is the ideal cycle for raw and cold products such as fish or pastry products as it does not damage the molecular structure.

It offers several possibilities to use predefined automatic cycles, to use the patented IFR cycle and other functions that facilitate daily tasks in food processing.

ICONS ON THE TOUCH SCREEN



Cabinet temperature and setpoint value (-40°C to +85°C)



Needle temperature and setpoint value (-40°C to +85°C)



Humidity and setpoint value



Missing time and setpoint time (00:00 to 24h:00)



Set fan speed (1 to 5)



Core temperature of the product during probe thawing process and setpoint value

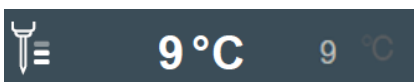

Surface temperature during probe thawing process and setpoint value



Button to return to main menu



Back button



Forward button



Cycle activation button



Cycle stop button



Save cycle button



Button for adding a holding phase post cooking process



Button for adding a blast-chilling phase post cooking process



Skip preheating phase button – During the preheating phase the machine arrives at the set setpoint without introducing humidity and without giving the start at the beginning of the cycle – When the temperature has been reached the following dialogue box appears (*)



Button to view the phases following the current one – Setpoints can be configured accessing the screens



Button for modifying the defrost end temperature during the defrost cycle



Confirm setpoint or time change



Machine standby button



Setting/configuration button



Progression of phases

WARNING ICONS ON THE TOUCH SCREEN



Alarm in progress – Type on the icon to access the alarm menu and view the anomaly – See alarms paragraph



Button to view the status of the cycle in progress – The first screen displays the start and end of cycle data – The next screen displays the values of the probes, inputs and outputs and alarms



End of preheating signal

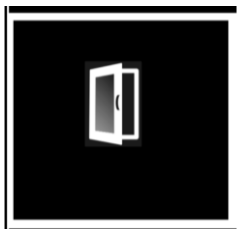

Door open signalling

MAIN CYCLE ICONS



Blast-chilling in progress



Blast-freezing in progress



Infinity cycle in progress



Low temperature cooking cycle



Thawing cycle



Leavening cycle



Preservation cycle



Pasteurization cycle



Drying cycle



Yogurt cycle



Chocolate cycle



Sanitation cycle



Defrost cycle

FIRST START-UP

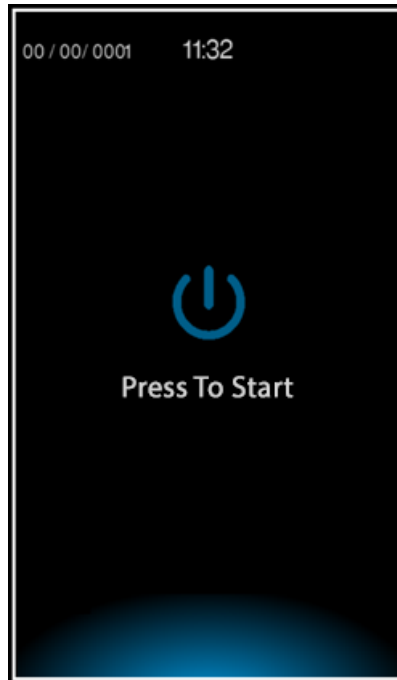

At first start-up, the operator will be asked to choose the language.

LANGUAGE SETTING

Select the desired language.

Select button  to confirm and access the main menu.

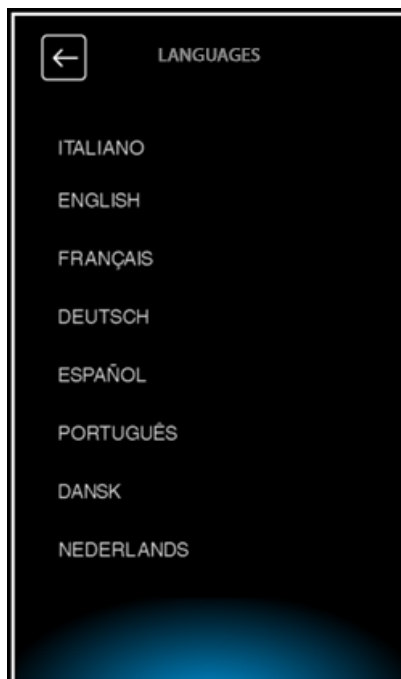

PROGRAMS

BLAST-CHILLING

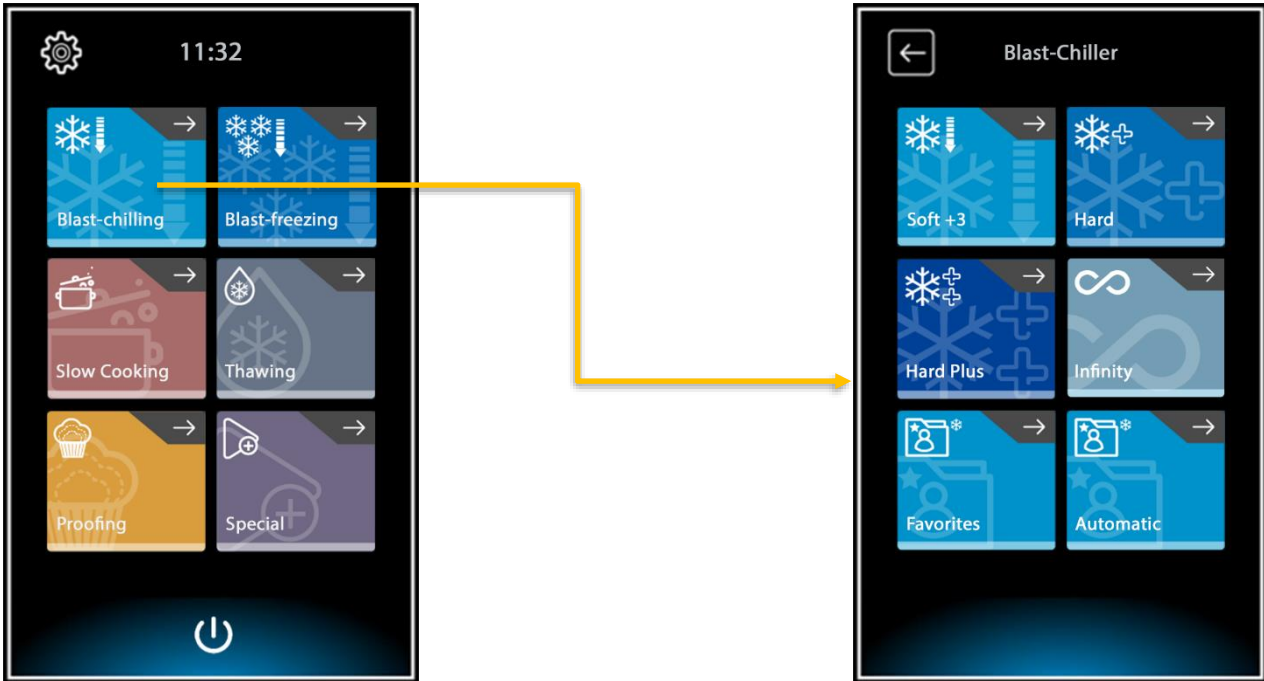

SOFT +3°C	<p>Cycle carried out through probe at the core or time-controlled, suitable for chilling foods up to +3°C, using a cabinet temperature varying from -5°C to 1°C.</p> <p>Cycle suitable for delicate products such as mousse, puddings, desserts, vegetables or foods that are not very thick</p>
HARD	<p>Cycle carried out through probe at the core or time-controlled, suitable for chilling foods up to +3°C, using a cabinet temperature varying from -15°C to 1°C.</p> <p>Cycle suitable for very dense products, with high fat content or medium sized products</p>
HARD PLUS	<p>Cycle carried out through probe at the core or time-controlled, suitable for chilling foods up to +3°C, using a cabinet temperature varying from -20°C to 1°C.</p> <p>Cycle suitable for very dense products, with high grease content or large sized products</p>
INFINITY	<p>Time-controlled blast-chilling/blast-freezing cycle with infinite duration, suitable for cooling various type food pans. The temperature at the core can be checked.</p>
FAVORITES	<p>Soft+3, Hard, Hard Plus cycles customised by the user and made favourite</p>
AUTOMATIC	<p>Manufacturer-defined cycles</p>

AUTOMATIC BLAST-CHILLING

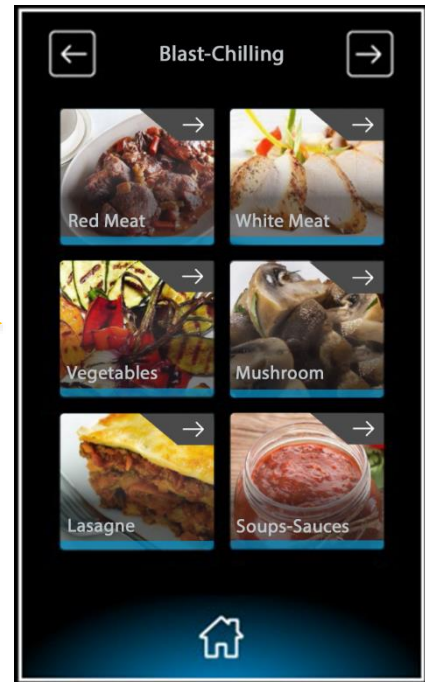

RED MEATS
WHITE MEATS
VEGETABLES
MUSHROOMS
LASAGNE
SOUPS AND SAUCES
RICE AND PASTA
CROISSANT
SHEET DOUGH
MOULDED LEAVENED
PUDDINGS
PANNA COTTA
LEAVENED +3
LEAVENED +10
SHORT PASTRY
FILLED PRODUCTS
TART
COOKED BREAD

Cycles developed by the company to facilitate the user in the blast-chilling process

BLAST-FREEZING

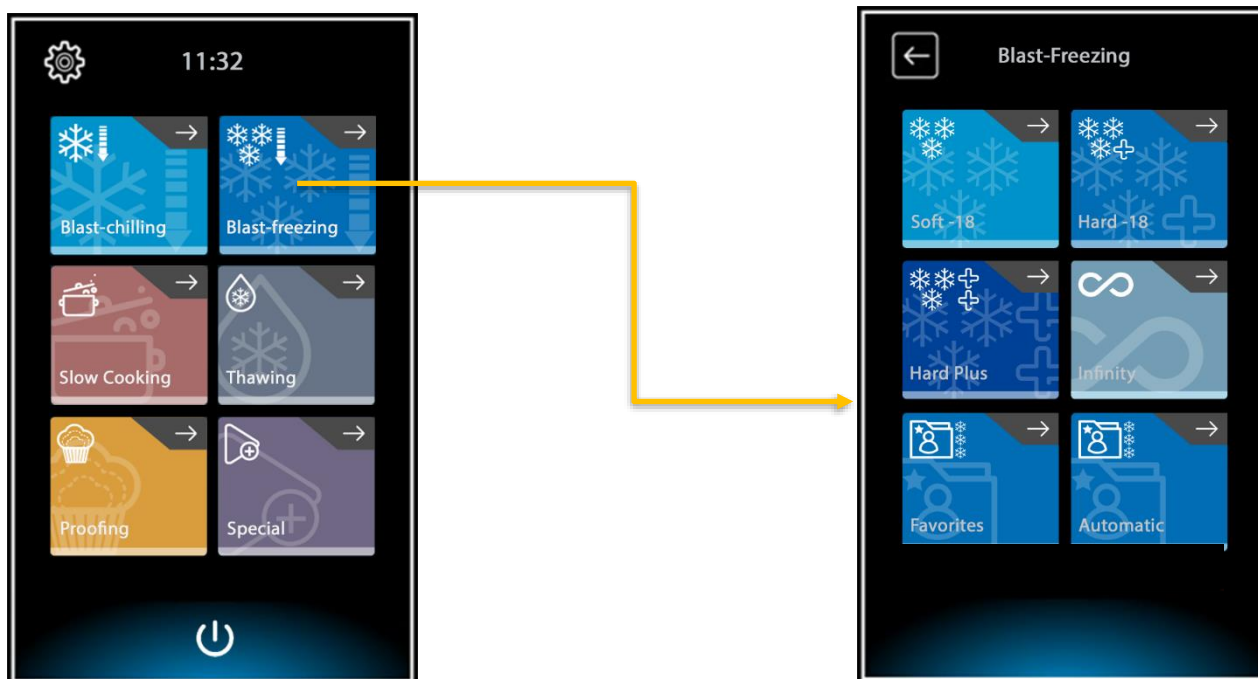

SOFT -18°C	<p>Cycle carried out through probe at the core or time-controlled, suitable for chilling foods up to -18°C, using a cabinet temperature varying from 1°C to -40°C.</p> <p>Cycle suitable for leavened products, baked or cooked foods that are not very thick</p>
HARD -18°C	<p>Cycle carried out through probe at the core or time-controlled, suitable for chilling foods up to -18°C, using a cabinet temperature that can reach -40°C.</p> <p>Cycle suitable for raw or cooked, medium size foods</p>
HARD PLUS	<p>Cycle carried out through probe at the core or time-controlled, suitable for freezing foods up to -18°C, using a cabinet temperature that can reach -40°C.</p> <p>Cycle suitable for raw or cooked, large size foods</p>
INFINITY	<p>Time-controlled blast-chilling/blast-freezing cycle with infinite duration, suitable for cooling various type food pans. The temperature at the core can be checked.</p>
FAVORITES	<p>Soft+-18, Hard -18°C, Hard Plus cycles customised by the user and made favourite</p>
AUTOMATIC	<p>Manufacturer-defined cycles</p>

AUTOMATIC BLAST-FREEZING

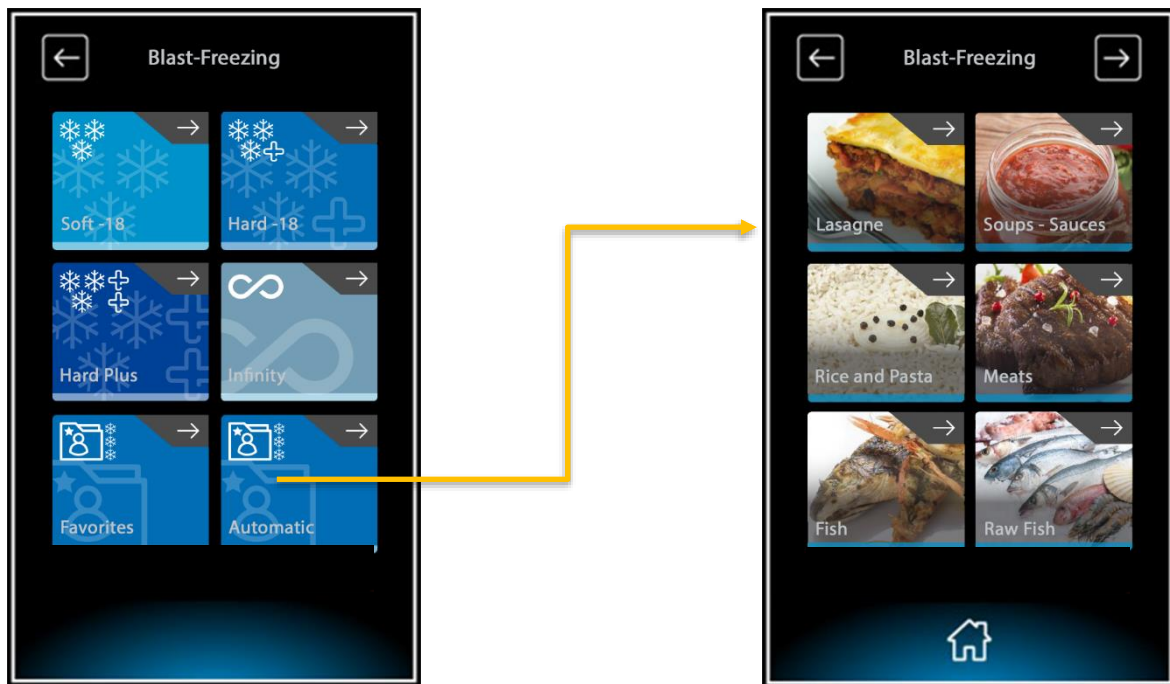

LASAGNE
SOUPS AND SAUCES
RICE AND PASTA
MEATS
FISH
RAW FISH
SUSHI
COOKED VEGETABLES
LEAVENED CAKES
COOKED TART
PRE-COOKED TART
COOKED BREAD
RAW BREAD
ICE CREAM -14°C
ICE CREAM -18°C
MOUSSE MONO
MOULD MOUSSE

Cycles developed by the company to facilitate the user in the blast-freezing process

SLOW COOKING

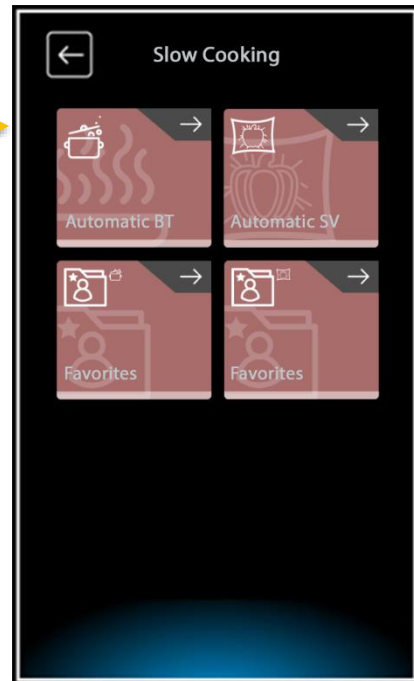

AUTOMATIC SLOW COOKING	List of cycles developed by the company for low temperature cooking, including a user-managed customised cycle with the possibility of making it a favourite.
AUTOMATIC VACUUM COOKING	List of cycles developed by the company for low temperature cooking in vacuum cooking mode, including a user-managed customised cycle with the possibility of making it a favourite.
SLOW COOKING FAVORITES	List of customised cycles made favourites by the user.
VACUUM COOKING FAVORITES	List of favourite programs for the user-defined low temperature vacuum cooking process.

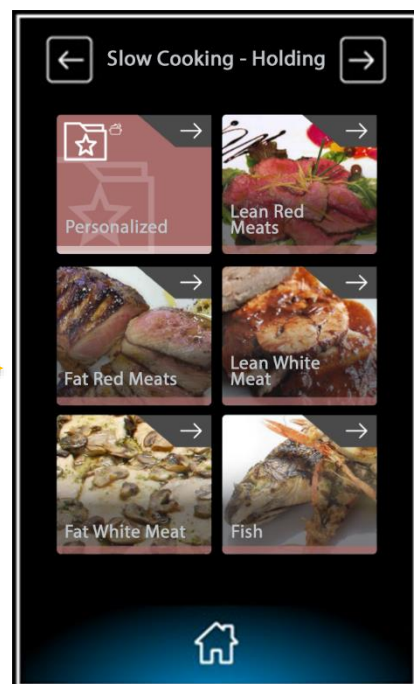
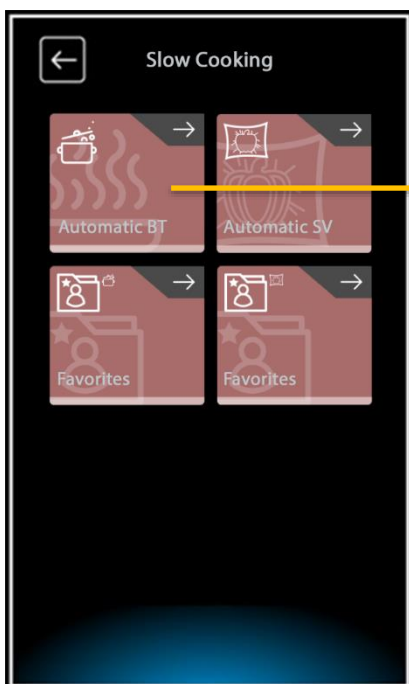

THAWING

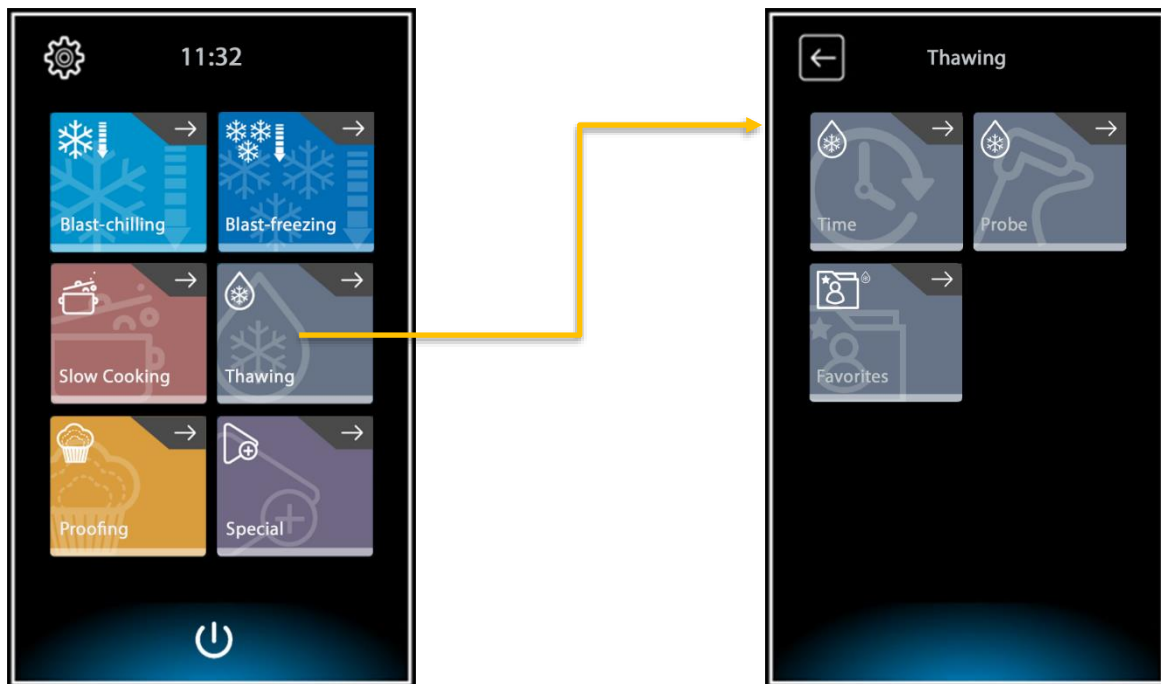

TIME	Thawing cycle carried out in time mode in compliance with HACCP requirements with no danger of high surface temperatures. The user can modify the parameters pre-set by the company following HACCP risk assessment.
PROBE	Multi-point core probe thawing cycle. Correct positioning of the probe inside the product enables compliance with HACCP requirements. The external sensor of the core probe must be positioned close to the surface of the food.
FAVORITES	List of user-defined favourite cycles for the thawing process.

LEAVENING



LEAVENING	Cycle for the direct leavening process to facilitate the end user to be immediately operational using his/her experience.
STOP LEAVENING	Cycle for the scheduled leavening process to facilitate the end user to set up a process using his/her experience. Lets the user set the date and time of the end of the process, managing the following phases: Cooling – Preservation – Reactivation – Leavening - Holding
FAVORITES	List of user-defined favourite cycles for the leavening and retarder prover process.
AUTOMATIC	List of preferred cycles for the leavening and proving process using the company's experience.

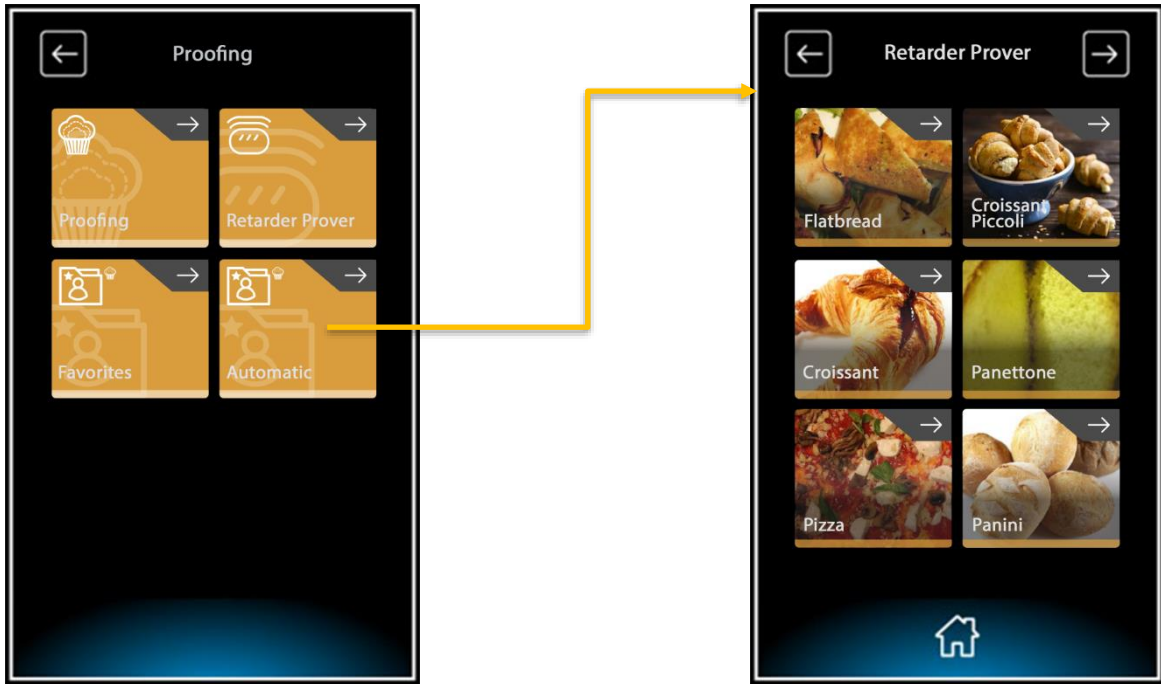

PUFF LEAVENED PRODUCTS	Cycles for the leavening process to facilitate the end user to be immediately operational using the company's experience.
SMALL CROISSANT	
CROISSANT	
PANETTONE	
PIZZA	
ROLLS	
BREAD	

SPECIAL CYCLES



IFR	I.F.R. is the patented positive blast-chilling system that automatically optimises the process for any type of food, no matter the size and quantity, chilling its surface thanks to the use of a three-sensor multi-point needle probe.
PRESERVATION	Cold holding cycle for both positive and negative temperatures.
ANISAKIS 24H	Freeze cycle that allows the preventive and comprehensive sanitation of fish product. The probe detects when food core temperature has reached -20°C, giving the machine the input to start the "24-hour devitalization" phase.
ANISAKIS 15H	Freeze cycle that allows the preventive and comprehensive sanitation of fish product. The probe detects when food core temperature has reached -35°C, giving the machine the input to start the "15-hour devitalization" phase.
YOGURT BOX	Cycle for making creamy, natural yogurt.
CHOCOLATE	Cycle for crystallizing chocolate.
PASTEURIZATION	Pasteurization cycle designed in 3 modes, Fast - High - Low, to meet user requirements.
DRYING	Cycle for processing thin slices of fruit or vegetables – During the process, keep the door half-open in order to facilitate the escape of internal humidity.
PRE-COOLING	Pre-cooling cycle of the internal cabinet in order to prepare the cabinet for subsequent blast-chilling or blast-freezing cycles.
PREHEATING	Pre-heating cycle of the internal cabinet in order to prepare the cabinet for subsequent low temperature cooking cycles.
HOLDING	Holding cycle to maintain the cabinet at a constant temperature to keep food or tableware warm.

NEEDLE PROBE HEATING	Probe heating cycle to facilitate extraction from thick frozen foods.
DEFROST	Defrost cycle in order to eliminate the ice formed on the fins of the evaporating coil.

BLAST-CHILLING/BLAST-FREEZING CYCLE

Blast-chilling/blast-freezing cycles predefined by the manufacturer and activated from the blast-chilling/blast-freezing screen SOFT, HARD, HARD PLUS, INFINITY.

When the desired cycle is selected, the machine starts to run. During execution of the cycle the parameters can be viewed and modified temporarily. The new values will be valid exclusively for the cycle in progress.



The 'In Progress' screen displays the following information and controls:

- Header:** 1/4, In Progress, 0min
- Step Indicator:** A right-pointing arrow icon, the date and time '01/ 01/22 10:25', and a snowflake icon with a vertical bar chart.
- Temperature 1:** A thermometer icon, '23 °C', and '120 °C'.
- Temperature 2:** A hand icon, '80 °C', and '250 °C'.
- Time:** A clock icon, '--- min', and a pencil icon.
- Speed/Fan:** A fan icon, a bar chart, and the number '2'.
- Bottom Bar:** A floppy disk icon (Save) and a square icon (Stop).

Callout boxes provide the following instructions:

- Top Left:** Select to display the next steps of the current cycle. (Points to the right arrow icon)
- Top Right:** Select to display information about the current cycle. (Points to the snowflake icon)
- Middle Left:** Select to modify the desired parameter. (Points to the thermometer and hand icons)
- Bottom Left:** Select to save the set cycle. The cycle will be visible in the FAVORITES (Points to the floppy disk icon)
- Bottom Right:** Select to stop the cycle and return to the previous screen (Points to the square icon)

At the end of the cycle because it has reached the core probe value or due to time, the machine will thermostat at the set preservation temperature until the user decides to stop the cycle.



MODIFY PARAMETERS

Parameters can be modified either by unit increments or macro increments using the scroll bar.

Select the parameter to be modified.

Once the change has been made, press OK to confirm and exit the change menu or  to cancel the modification request.

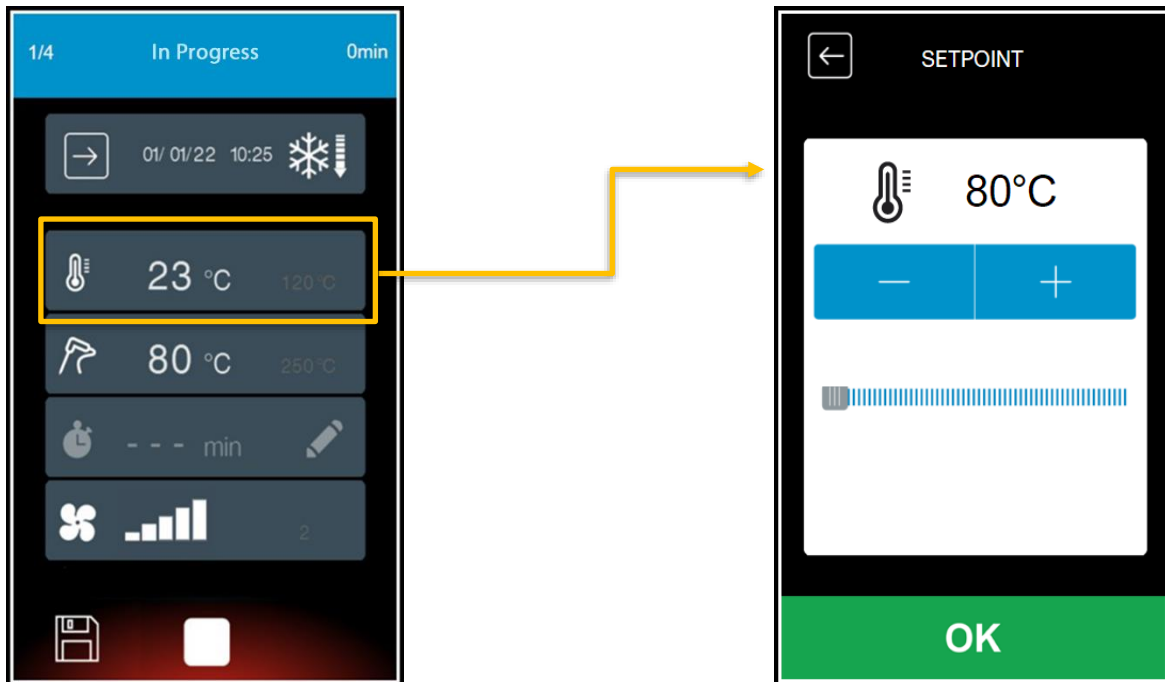

CYCLE INFO

Information on the current cycle can be displayed.

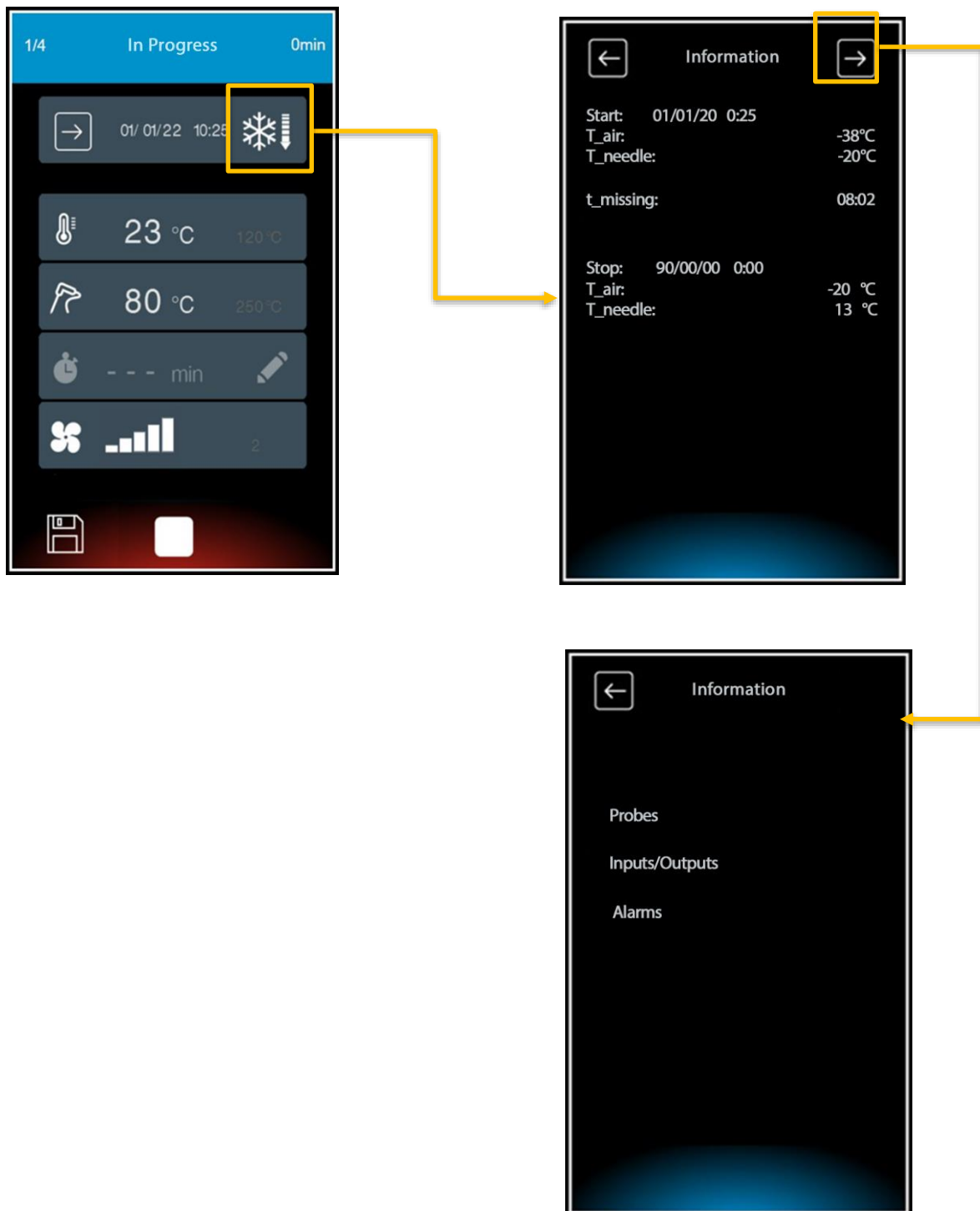

RECIPE SAVING

Type on the SAVE icon and the controller will ask for the location where to save the program (P1, P2, etc.). If the user chooses to overwrite an existing program, the controller will ask for confirmation and will propose the existing name or its modification.

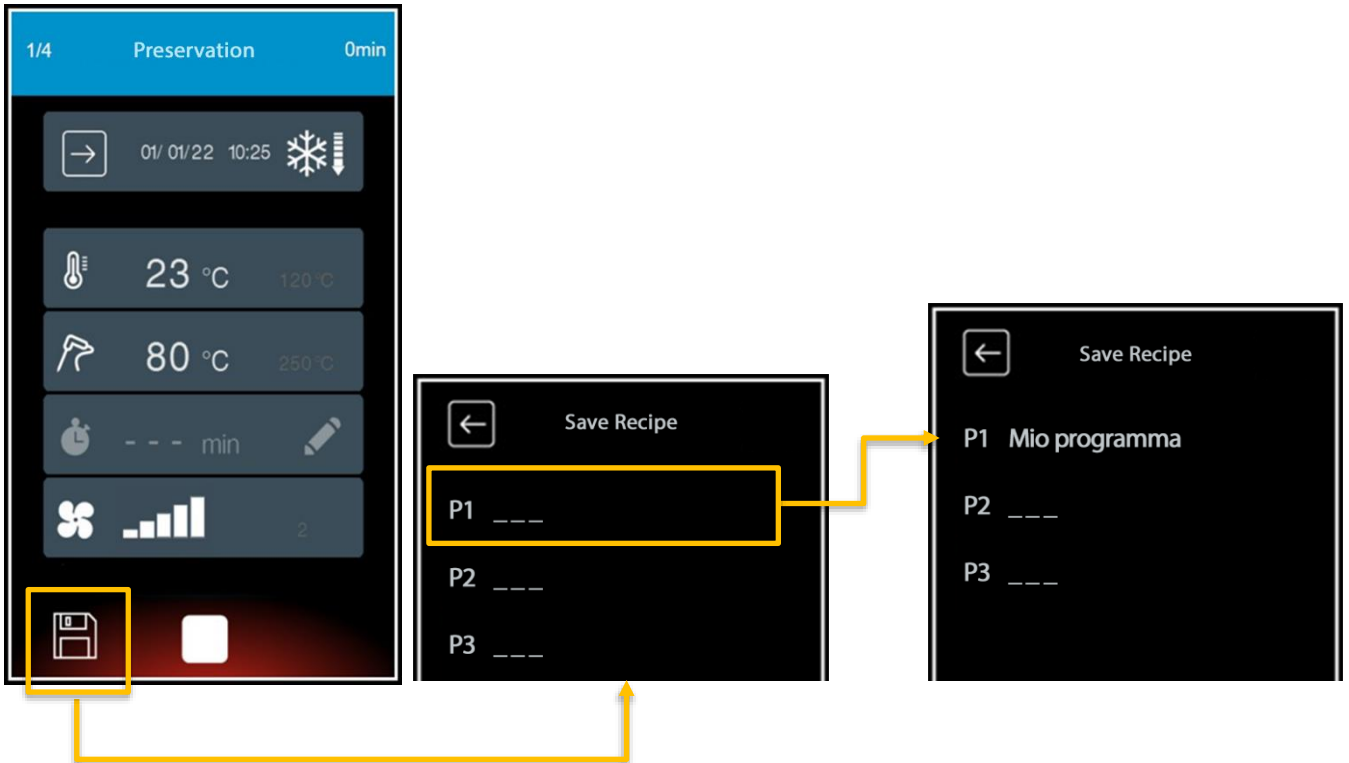

Subsequently, accessing the favorite cycles icon, it is possible to view the list of available recipes.

Select the recipe to delete or activate the cycle.

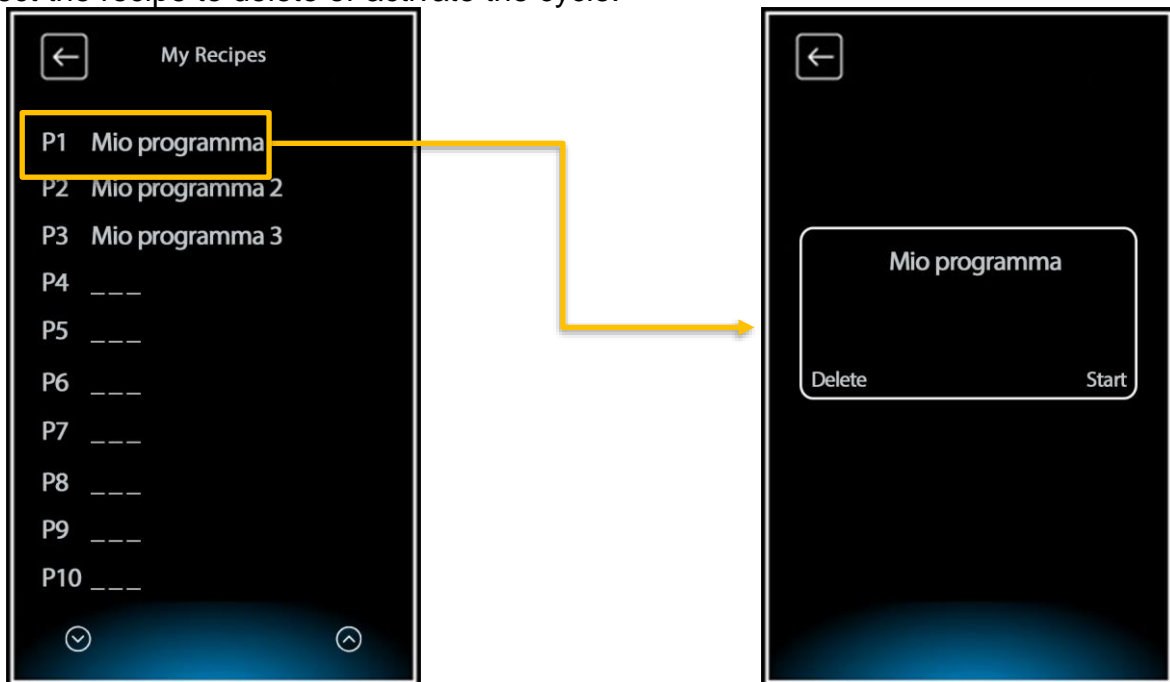

Choosing DELETE deletes the program.

Resetting causes the favorite programs to be repositioned.

LOW TEMPERATURE COOKING CYCLE

Low temperature cooking cycle with the possibility of setting a second phase for cold preservation or warm holding.

When the desired cycle is selected, the machine waits for the second phase to be selected before starting to run.

While the cycle is running, it is possible to view the set points and modify them.

The cooking cycle can be adapted to the type of food by changing the air temperature, humidity and fan speed.

The cycle can be carried out with core probe (cooking ends when the set core temperature is reached and then switches to the second phase if set) or in time mode (cooking ends after the set time has elapsed and then automatically switches to hold if HOLD or CHILL phase is set).

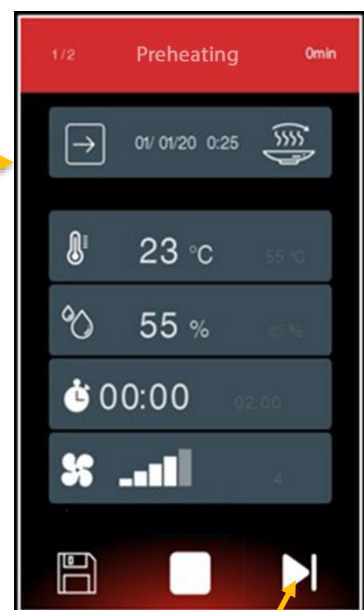
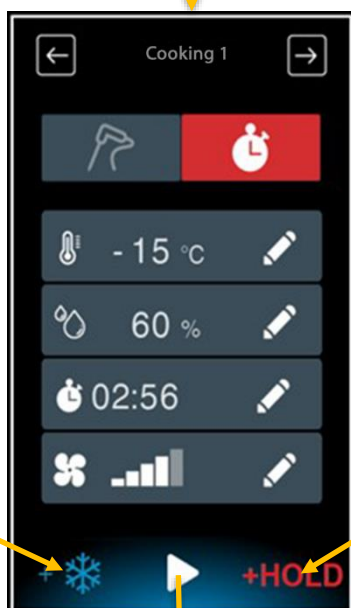
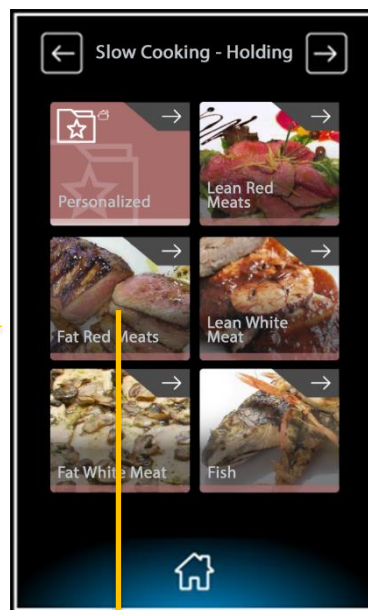
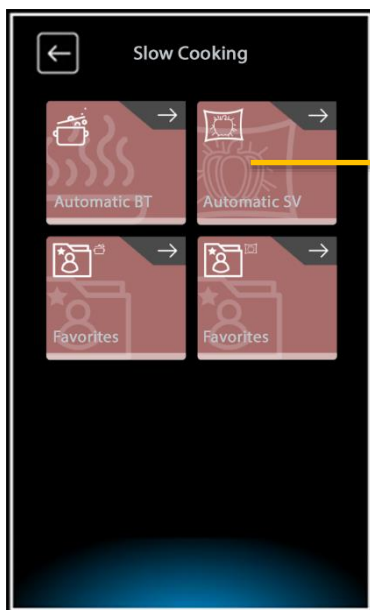

Select to enter the post-cooking blast-chilling phase

Select to enter the post-cooking holding phase

Select to by-pass the preheating cycle

DIRECT LEAVENING CYCLE

Direct leavening is used for bread and pastry doughs by managing temperature, humidity and time. This process improves product quality and eliminates long waits for bakers; the doughs are in fact prepared and once ready are processed by the equipment through the selection of parameters such as temperature, humidity and ventilation.

When “leavening” is selected, the machine proposes a blast-chilling cycle and a subsequent leavening cycle.

During the cycle the machine lets you set the cabinet setpoint, humidity rate and ventilation speed.

At the end of the process the machine switches to holding.



SCHEDULED LEAVENING CYCLE

Scheduled leavening is used for bread and pastry doughs by managing temperature, humidity and time. This process improves product quality and eliminates the night work of the bakers; the doughs are prepared during the day and once ready they are fed into the equipment. Scheduled leavening requires that the user set the time and day of the end of the cycle. The user can then set the various phases, bearing in mind that in the event of inconsistent durations/times of the various phases, the controller will display a warning message.



When “stop leavening” is selected, the machine proposes a cycle of blast-chilling, preservation, reactivation, leavening and a subsequent slowing down cycle. Before starting, the machine asks you to set the date and time of the end of the cycle.

During the cycle the machine lets you set the cabinet setpoint, the humidity rate and the ventilation speed and to change the date only if the preservation phase is active. At the end of the process the machine switches to slowing down.



TIMED THAWING CYCLE

The timed thawing process lets the user have food ready to be cooked. To start the cycle, set the start and end day and confirm/modify air temperatures, times and ventilation for each of the 8 process steps. Bear in mind that the preset parameters for the 8 phases (cabinet temperature, ventilation and times) have been optimized in order to ensure that during a thawing process the food is treated in compliance with HACCP requirements. At the end of the process the machine will go into a cold holding phase. It is possible to save the cycle in favorites.

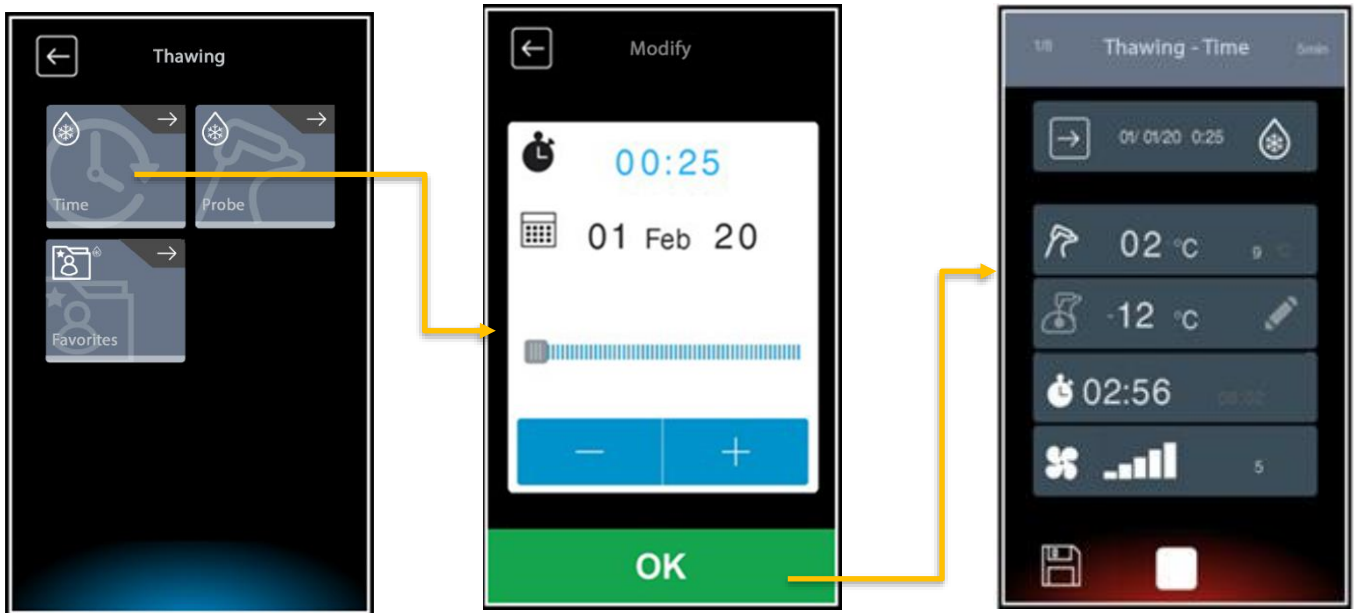

PROBE THAWING CYCLE

The probe thawing process lets the user start the cycle by accepting the sequence of surface temperature, core probe and fan speed settings suggested by the company through 5 process steps.

At the end of the process the machine will go into a cold holding phase. It is possible to save the cycle in favorites.

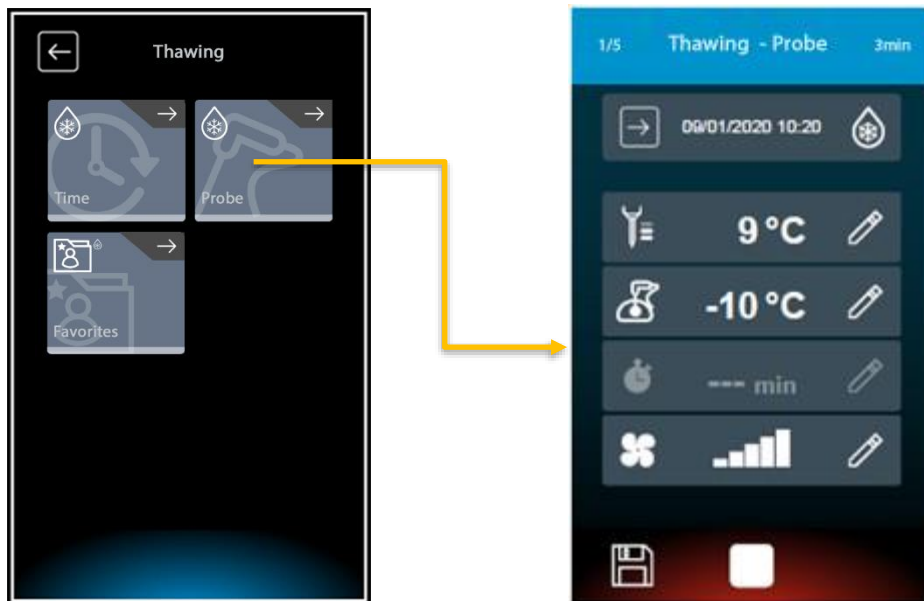

Pay attention to the correct position of the needle probe, ensuring that one of the three sensors is close to the surface of the food.

SPECIAL CYCLES - I.F.R.



(Intelligent Food Recognition)

The IFR is an innovative patented system of positive quick cooling which allows the cycle optimisation for each type of foodstuffs **by preventing superficial freezing.**

Temperatures are detected by a three-sensor multipoint needle probe. The position inside the foodstuff is determined univocally by a reference disk located along the needle.

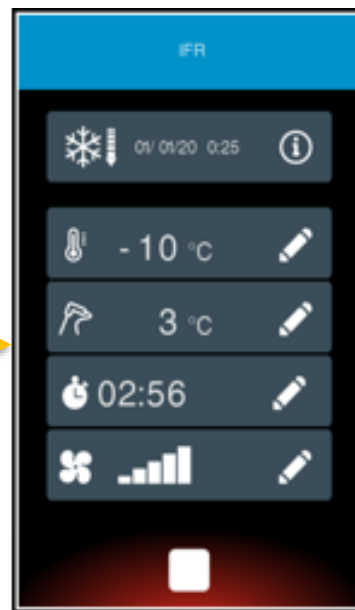

SETTINGS

SERVICE

Set the password “-19” to access the Service menu.

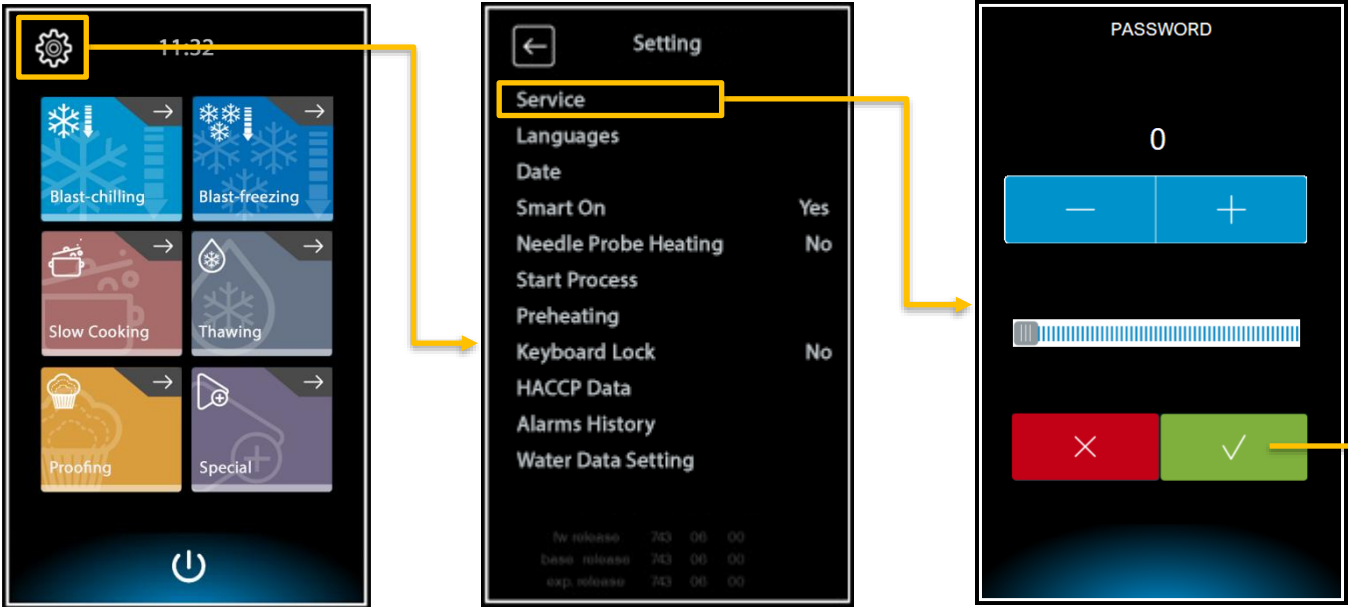

PARAMETERS CONFIGURATION and other items can be selected in the SETUP menu.

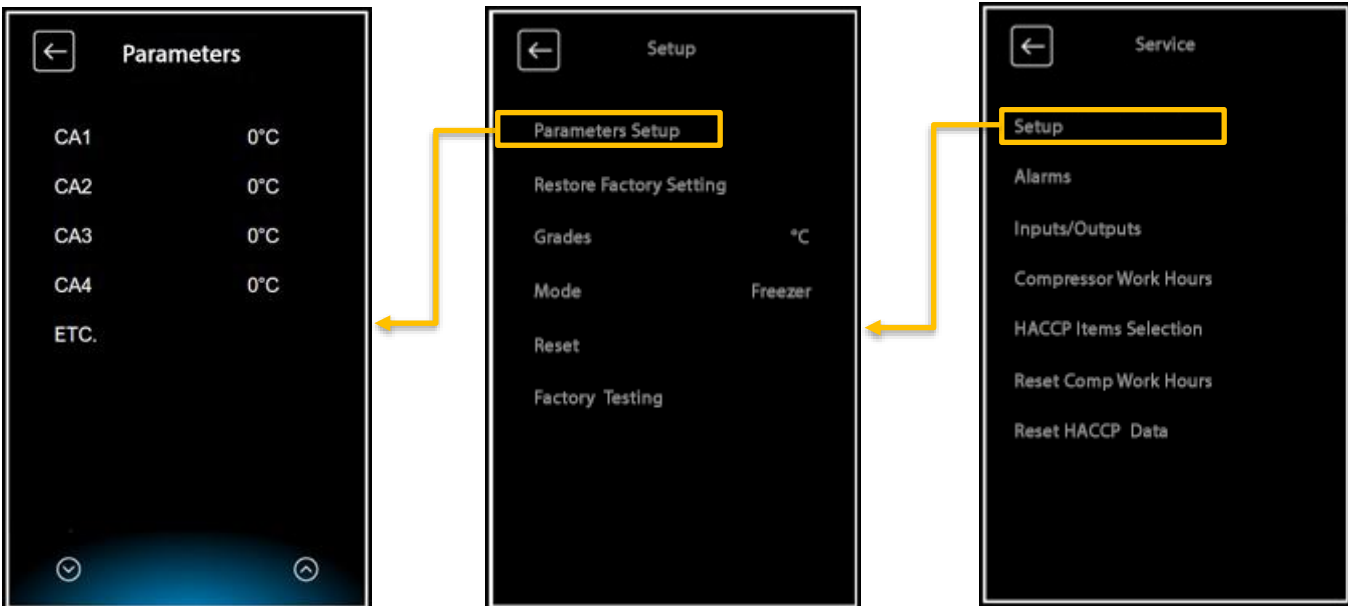

WATER DATA SETTING

The following parameters can be selected on the setting page so that the controller tells the user what maintenance to do to the atomiser nozzle in order to ensure correct water supply in processes where humidity is required.



IMPORTANT

Refer to the chapter “WATER CONNECTION”

WATER

Confirm presence or absence

WATER SOFTENER

Confirm presence or absence

WATER HARDNESS

less than 8°f

less than 18°f

less than 30°f

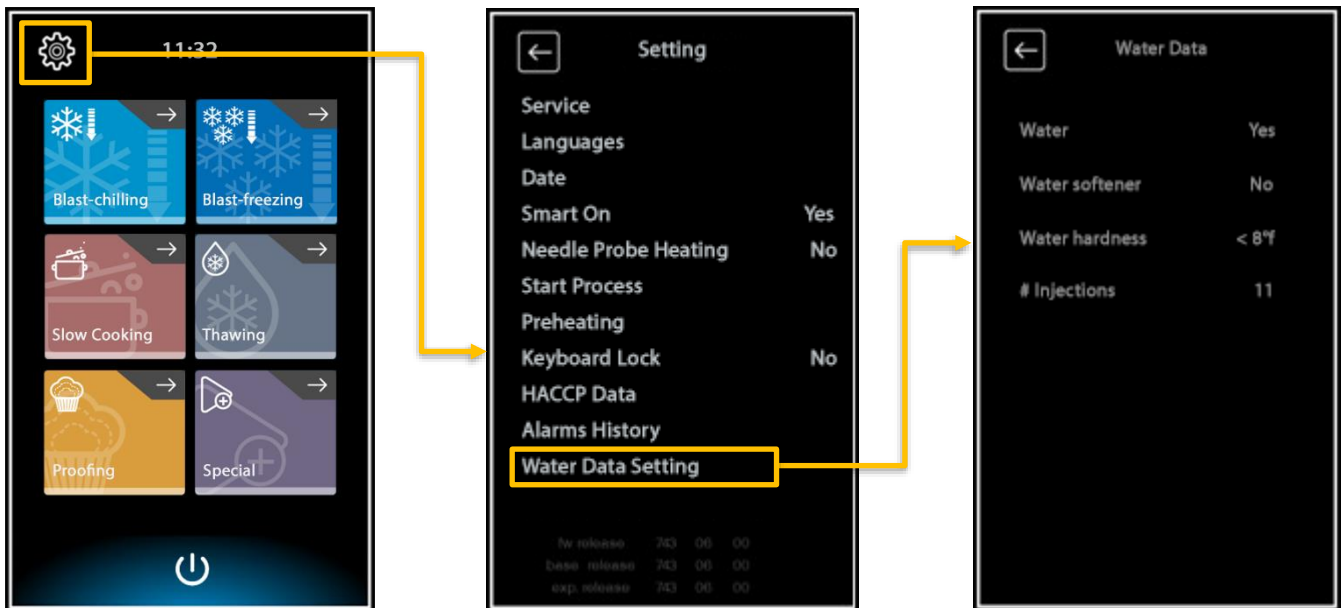

HACCP DATA

On the HACCP DATA page, you can view data on the cycles performed.

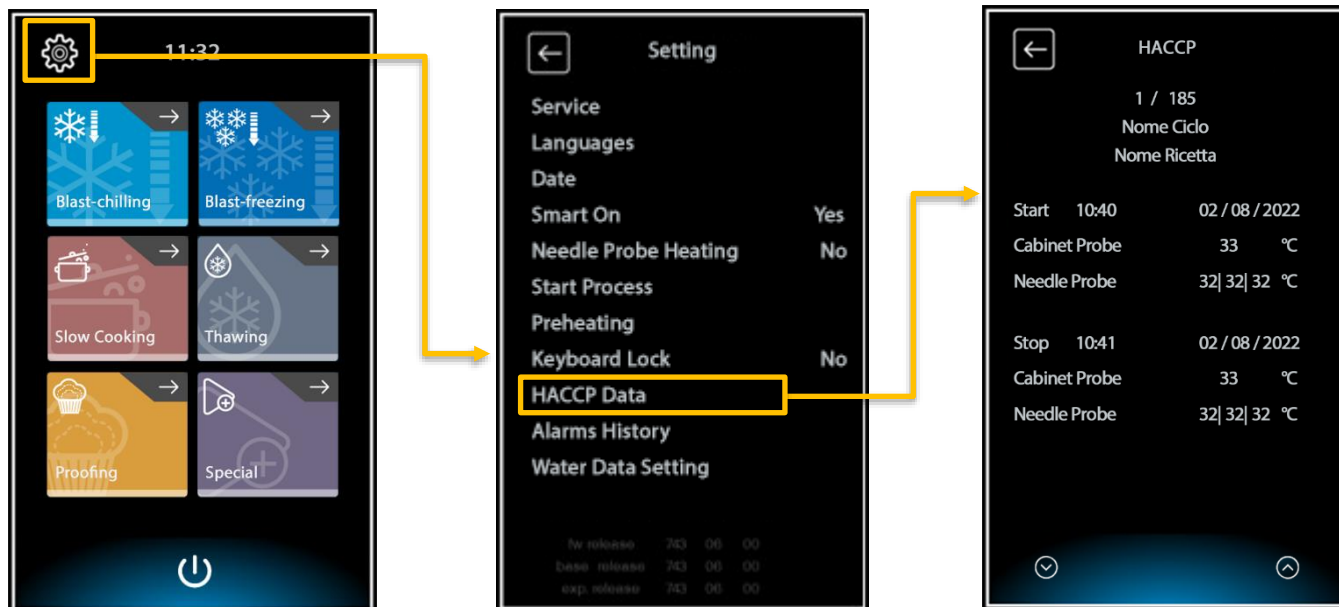

DOWNLOAD HACCP DATA

Insert a pen drive (*not supplied*) into the USB port at the bottom of the circuit board holder.

Press the button .



Choose the option "HACCP DATA DOWNLOAD".

Confirm  to proceed with the DOWNLOAD.

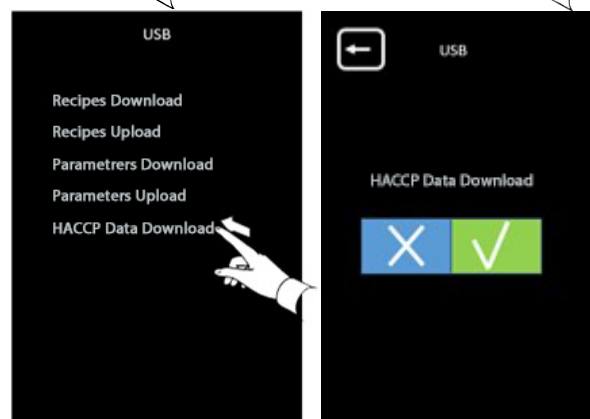

Select the date and time of the start of data logging using the -/+ buttons and confirm ✓ to proceed.

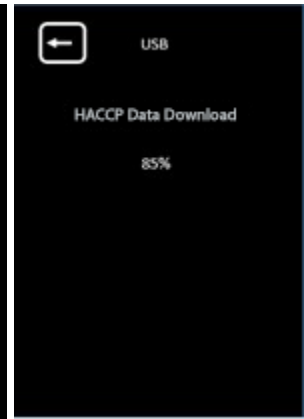

Upon completion of the DOWNLOAD, the successful download will be indicated.

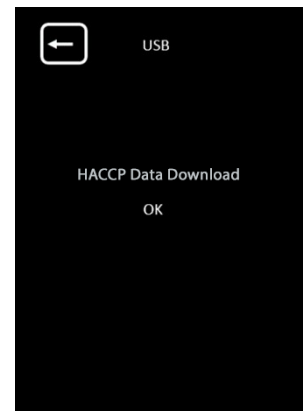

You can now remove the pen drive.

MAINTENANCE



WARNING

Refer to the chapter “Safety warnings and information”

ROUTINE MAINTENANCE

The following care operations must be carried out by an operator.



IMPORTANT

Problems resulting from a lack of care as described below will not be covered by the warranty.



WARNING

Before any operation, disconnect the equipment from the electrical mains.

It is advisable to clean the internal cabinet weekly or when the equipment is idle for more than 12 hours; increase the frequency of cleaning according to use of the equipment.

Cleaning the interior and accessories

Before use, clean all internal parts and accessories with lukewarm water and neutral soap or with products that are more than 90% biodegradable (to reduce the emission of pollutants into the environment), then rinse and dry thoroughly.

The conformation of the cabinet and the design of the internal components allow all parts to be washed and cleaned accordingly.

CAUTION



DO NOT USE STEEL WOOL OR SIMILAR MATERIAL TO CLEAN STAINLESS SURFACES.

DO NOT USE CHLORINE, SOLVENT-BASED CLEANING AGENTS (SUCH AS TRICHLOROETHYLENE ETC.) OR ABRASIVE POWDERS.



NEEDLE PROBE CLEANING



IMPORTANT

Take particular care uses the needle probe, bearing in mind that it is a sharp object that must be handled with particular care when cleaning.



We recommend cleaning the needle probe periodically to ensure its optimal operation. The probe should be cleaned manually using lukewarm water and mild soap, then rinsed with clean water and disinfectant solution.



CAUTION

Never clean the probe with boiling water.

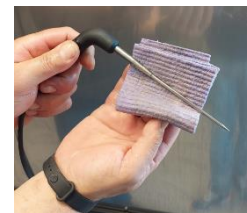

TRAY HOLDERS AND INNER STRUCTURE

The tray holders and inner structure are removable and dishwasher-safe.

Proceed as shown in the figure below to remove them.



DRAIN PLUG

During cooking cycles, remove the cap to drain the water on the internal bottom of the chamber.

To clean the drain plug, remove it as shown in the figure.



Clean it with lukewarm water and mild soap, then rinse and dry thoroughly.

OTHER SURFACES

Clean plastic and metal parts only with non-aggressive cleaning agents. Stop using these products immediately if you detect any visual or tactile changes to the surfaces and rinse with water (e.g. discolouration plastic/fusion/other, or rust marks/scratches on metal). Dry carefully after rinsing.

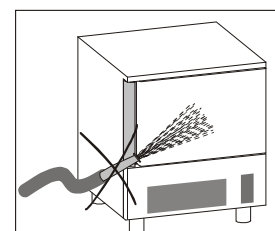

Do not aim jets of water directly at the unit to clean it, especially avoid the use of pressure lances.

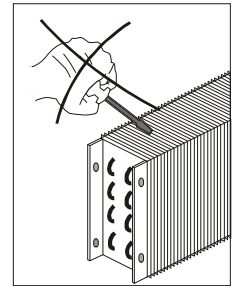

Do not rinse with sharp or abrasive tools, especially the evaporator.

You may clean inside the evaporator after loosening the knobs and rotating the protection component.

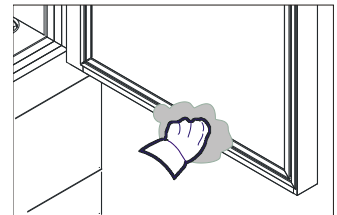

Wash the door gasket with water. Accurately dry with a dry cloth. We recommend wearing protecting gloves throughout the operations.

CLEANING THE AIR CONDENSER

The air condenser should be kept clean to ensure the appliance's performance and efficiency, as air should freely circulate inside the appliance.

The condenser should therefore be cleaned every 30 days, using non-metal brushes to remove all dust and dirt from condenser blades.

Access to the condenser is from the front.
Unhook the front guard, pulling it towards you.

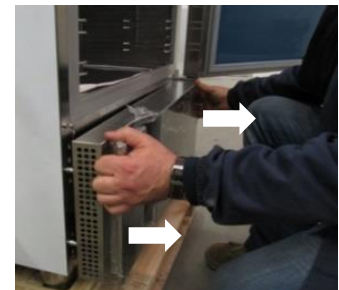

STAINLESS-STEEL MAINTENANCE

By stainless steel we mean INOX AISI 304 steel.
We recommend following the instructions below for the maintenance and cleaning of stainless-steel parts.
This is of the utmost importance to ensure the non-toxicity and complete hygiene of the processed foodstuffs.
Stainless-steel is provided with a thin oxide layer which prevents it from rusting. However, some detergents may destroy or affect this layer, therefore causing corrosion.
Before using any cleansing product, ask your dealer about a neutral chloriness cleansing product, as to avoid steel corrosions.
If the surface has been scratched polish it with fine STAINLESS-STEEL wool or a synthetic-fibre abrasive sponge. Always rub in the direction of the silking.

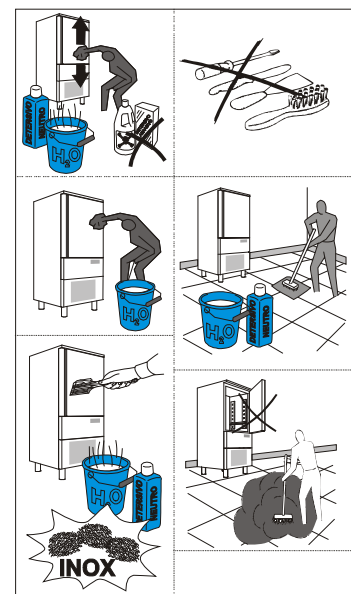

PRECAUTIONS IN THE CASE OF LONG PERIODS OF INACTIVITY

Observe the following precautions during long periods of inactivity:

- Disconnect the power supply;
- Remove all food from the cabinet and/or drawers and clean the interior and accessories;
- Clean the cabinet vigorously and all stainless steel surfaces using a cloth slightly soaked in Vaseline oil, so as to spread a protective film;
- Leave the door open to facilitate air circulation to prevent the formation of unpleasant odours;
- Cover the compressor unit with a nylon cloth to protect it from dust;
- Air the premises out periodically.

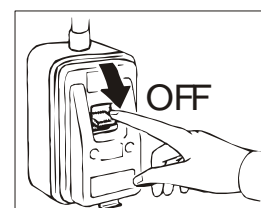

After maintenance work is completed, it must be ensured that the machine is able to work safely, and in particular that the protective and safety devices are fully functional.

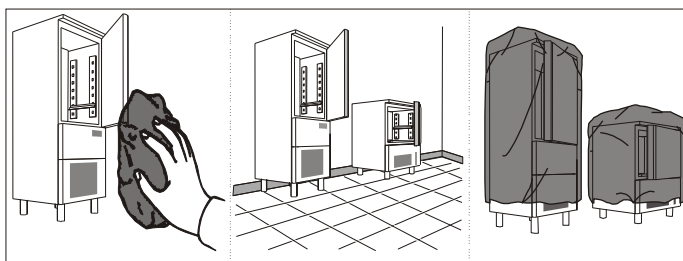

TROUBLESHOOTING

ANOMALY TABLES

The equipment always displays a warning message or an alarm in the event of an anomaly. Type on the warning icon to view the status of the outputs/inputs to display the alarm. The warning remains active until the problem is resolved.



Warning icon

Follow the instructions provided by the equipment and contact Customer Service if required, remembering to:

- Disconnect the equipment from the electrical system;
- Deactivate the protection switch upstream of the equipment;

The controller records 40 alarm events. The events are recorded in the list in the Settings menu (Alarm History).

In some cases, faults can be resolved quickly and easily by following the instructions in the following troubleshooting guide:

Type of anomaly	Description	Possible Causes	Actions
RTC	Low battery level.	<ul style="list-style-type: none"> Control interface battery is flat. Circuit board fault. 	Problem with the internal clock battery. Clock functions will not work correctly (e.g. HACCP event recording will be incorrect). CALL FOR SERVICE.
CABINET PROBE	Cabinet probe fault.	Probe connector disconnected from terminal. Probe and/or probe cable damaged or interrupted.	The blast-chiller will run until the end of the active cycle. No further cycle can be run until the probe is replaced by Technical Service. CALL SERVICE.
EVAPORATOR PROBE	Evaporator probe fault.	Probe connector disconnected from terminal. Probe and/or probe cable damaged or interrupted.	The blast-chiller works: the defrost setting is time-dependent. CALL SERVICE.
CONDENSER PROBE	Condenser probe fault.	Probe connector disconnected from terminal. Probe and/or probe cable damaged or interrupted.	CALL SERVICE. Fault locking an active cycle. Remove load from cabinet to avoid food waste.
NEEDLE SENSOR 1	Needle sensor 1 fault	Improper use of the needle probe (e.g. pinched or frayed wire). Connector fault. Probe fault. PCB fault.	<p>Cycle running:</p> <ul style="list-style-type: none"> The cycle continues in probe mode until at least one of the 3 needle probe points is running. The cycle switches to time mode if none of the 3 sensors are operating. <p>During STANDBY phase:</p> <ul style="list-style-type: none"> The cycle can be started as long as at least one of the 3 points is active. The cycle can be started in time mode if all points are faulty. Call Service to restore full functionality. <p>Replace probe. Replace board. Call Service to restore full functionality.</p>
NEEDLE SENSOR 2	Needle sensor 2 fault	Improper use of the needle probe (e.g. pinched or frayed wire). Connector fault. Probe fault. PCB fault.	<p>Cycle running:</p> <ul style="list-style-type: none"> The cycle continues in probe mode until at least one of the 3 needle probe points is running. The cycle switches to time mode if none of the 3 sensors are operating. <p>During STANDBY phase:</p> <ul style="list-style-type: none"> The cycle can be started as long as at least one of the 3 points is active. The cycle can be started in time mode if all points are faulty. <p>Replace probe. Replace board. Call Service to restore full functionality.</p>
NEEDLE SENSOR 3	Needle sensor 3 fault	Improper use of the needle probe (e.g. pinched or frayed wire). Connector fault. Probe fault. PCB fault.	<p>Cycle running:</p> <ul style="list-style-type: none"> The cycle continues in probe mode until at least one of the 3 needle probe points is running. The cycle switches to time mode if none of the 3 sensors are operating. <p>During STANDBY phase:</p> <ul style="list-style-type: none"> The cycle can be started as long as at least one of the 3 points is active. The cycle can be started in time mode if all points are faulty. <p>Replace probe. Replace board. Call Service to restore full functionality.</p>

THERMAL SWITCH	Compressor thermal switch tripped.	Compressor overload. Inadequate power supply. (connector disconnected). Damaged compressor.	The blast-chiller is locked and only the condenser fan remains in operation. Check for any obstructions in the condensing coil. CALL CUSTOMER SERVICE.
HIGH PRESSURE	Safety pressure switch tripped.	The working ambient temperature is too high. The condenser fan does not work. The food load exceeds the suggested values. Condensing coil clogged with dust.	Reposition the machine to ensure proper ventilation. The blast-chiller is locked and only the condenser fan remains in operation. Check the connections of the fan and/or run condenser if present. Check for any obstructions in the condensing coil. Clean the condensing coil. CALL CUSTOMER SERVICE.
LOW PRESSURE	Safety pressure switch intervention.	Refrigerant leak resulting in insufficient charge. Evaporator fan not working. Solenoid valve locked. Evaporator coil with ice	The blast-chiller is locked and only the condenser fan remains in operation. Check solenoid valve functionality. Defrost. Check fan connections. CALL CUSTOMER SERVICE.
DOOR OPEN	Door open Stop cycle.	The door stays open beyond the permitted limit. Faulty or interrupted closing device (micromagnetic).	Make sure that the machine door is closed and that any physical obstructions are not preventing the door from closing. Check micro connections. If the alarm remains active call Service.
HIGH TEMPERATURE	High cabinet temperature	Door open. Food in the cold cabinet is too hot. Check the cabinet probe. Refrigerant leak. Ice or frost on evaporator.	Cabinet temperature has exceeded the set limit in addition to the signal delay. Cycle in continuous operation. Check parameter A4. Perform defrost cycle. Check the condition of the gasket. Check the cabinet temperature with an external thermometer. If the alarm persists even when the cabinet temperature is low, call Service.
LOW TEMPERATURE	Low cabinet temperature (only for positive or negative holding cycles)	Low set delay time. Set temperature difference too small. Evaporator frozen. Evaporator fan not working. Compressor always ON. Non-compliant temperature probe	The cabinet temperature is below the cycle temperature setpoint minus the differential. The cycle will continue until it stops. Open the door to raise the temperature inside the cabinet and check after about 3 minutes. Start a manual defrost cycle. Check compressor relay or contactor. Check internal temperature with reference thermometer Check parameter A1. If the problem persists, call Service.
CYCLE DURATION	Cycle time over the permitted limit	Food load in cabinet too high. Food too thick. Food temperature too high. Evaporator fan fault. Refrigerant leak.	The core temperature has not reached the setpoint within the set time period. Reduce thermal load. Reduce food thickness.
BOARD COMMUNICATION	Power board communication error	Internal error – circuit board disconnected – Circuit board fault.	Check whether the problem persists when ON/OFF is operated. If problem persists, call Service.
BOARD COMPATIBILITY	Corrupted stored parameters	Software corruption	Check whether the problem persists when ON/OFF is operated. If problem persists, call Service.
NEEDLE	Fault on all sensors.	Improper use of the needle probe (e.g. pinched or frayed wire). Connector fault. Probe fault. PCB fault.	Cycle running: <ul style="list-style-type: none"> • The cycle continues in probe mode until at least one of the 3 needle probe points is running. • The cycle switches to time mode if none of the 3 sensors are operating. During STANDBY phase: <ul style="list-style-type: none"> • The cycle can be started as long as at least one of the 3 points is active.

			<ul style="list-style-type: none"> The cycle can be started in time mode if all points are faulty Call Service to restore full functionality.
POWER FAILURE	Supply power absent.	No power. Power system failure. Other electrical problems (e.g. power loss). Damaged power cable. Fuse tripped.	The machine restarts, signalling intervention of the alarm. The cycle restarts automatically as soon as power is restored. The machine has not been used for a period of time: check the start and end time of the cycle. Check the plug or the general electrical control panel. Check for shorts or overload. If the alarm persists, call Service.
SANITATION PROBE INSERTION	NA	NA	NA
SANITATION DURATION	NA	NA	NA
CONDENSER OVERHEAT	High cabinet temperature	Incorrect condenser probe position. Fan condenser not working. The condenser is dirty or the ventilation grille has clogged holes. The machine cannot dissipate heat from the motor unit. Refrigerant leakage (compressor always ON).	This fault locks the active cycle: Remove load from cabinet to avoid food waste. Use a Hoover and remove any dirt/dust residue from the ventilation grille. If the alarm persists, call Service.
COMPRESSOR LOCKED	High cabinet temperature	Incorrect condenser probe position. Fan condenser not working. The condenser is dirty or the ventilation grille has clogged holes. The machine cannot dissipate heat from the motor unit. Refrigerant leakage (compressor always ON). Thermal relay tripped. Check parameters C7 and C8.	This fault locks the active cycle: Remove load from cabinet to avoid food waste. Use a Hoover and remove any dirt/dust residue from the ventilation grille. If the alarm persists, call Service.
NEEDLE PROBE INSERTION	Needle probe not inserted.	No needle probe insertion.	Check correct insertion of the needle probe. Reactivate the cycle and, if the problem persists, call Service.
HUMIDITY	Humidity probe fault.	Probe connector disconnected from terminal. Probe and/or probe cable damaged or interrupted.	CALL SERVICE. Fault locking an active cycle.
H2O INJECTION MAINTENANCE	Atomiser nozzle cleaning	The number of humidification cycles has exceeded the set limits depending on water hardness and temperature.	Call Service.
EXP COMMUNICATIONS	Expansion board communication error	Internal error – circuit board disconnected – Circuit board fault.	Check whether the problem persists when ON/OFF is operated. If problem persists, call Service.
EXP COMPATIBILITY	Corrupted stored parameters	Software corruption	Check whether the problem persists when ON/OFF is operated. If problem persists, call Service.
The display is switched off (OFF) while the main switch is on.		Display connector disconnected.	Switch the unit On/Off. If the problem persists, call Service.
The display is locked and does not react.		No power supply. Shorted fuses. Faulty electrical contacts. Problems with the software.	Switch the unit On/Off. If the problem persists, call Service.
The display has condensation on the inside.		Water infiltration during cleaning.	No action required if the unit can continue to operate. If a malfunction occurs, call Service.

External noise/vibration with cycle ON.	Unit not level. Water collection tray located underneath the motor vibrating. Condenser panel not secured.	Level the machine by operating the adjustable feet. Remove the water in the tray and adjust the support guides. Secure the condenser panel. If the problem persists, call Service.
Internal noise/vibration with cycle ON.	Tray holders are not aligned. Internal fan obstruction. Evaporator fan/casing deflector not properly secured.	Check that the right/left holders are properly levelled. Check that the cabinet fan is working properly without obstructions. Check that the casing is properly secured with the knobs. If the problem persists, call Service.
The machine takes too long to reach the desired temperature.	High food load. Refrigerant leakage. Condensing coil clogged with dust. Solenoid valve fault. Cabinet fan is not connected correctly. Thermostatic valve needs adjustment. Heating element relay is locked. Thermal insulation of piping Damaged Evaporator loaded with frost. Unsuitable door closure.	Reduce the food load in the cell. Clean the condensing coil. Defrost. If the problem persists, call Service.
Compressor fault	The compressor does not start. Compressor oscillates intermittently or discontinuously. Compressor thermal relay tripped. Compressor noisy. Clicson tripped. Contactor failure.	CALL SERVICE.
Failed defrost.	Check defrost parameters. Check defrost solenoid valve operation. Check that the defrost probe is reading correctly. Check heating element operation. Defrost program set with inappropriate parameters. Faulty bimetallic thermostat.	Check the defrost cycle setting (see operation and maintenance manual). Check bimetallic thermostat operation. Check evaporator heating element operation.
Evaporator fans not working.	Safety micro fault. Failure on run condenser (capacitor) of the fan. Faulty or short-circuited fan. Check electrical connections.	Check magnetic micro operation. Check the status of the fan condenser in the electrical panel. Check fan operation and replace if necessary.
Condenser fans not working.	Compressor not working. Fan capacitor failure Switch tripped – fans ON Faulty or short-circuited fan.	Check compressor operation. Check the status of the fan condenser in the electrical panel. Check whether the pressure switch has tripped. Check fan operation and replace if necessary.
Door does not close properly.	Worn gasket. Door misalignment.	Replace gasket. Check the correct (current draw) and surface temperature of the door resistance. Adjust door brackets.

(tab 11)

Once the above checks have been carried out, if the defect persists, contact Customer Service, remembering to indicate:

- The nature of the defect
- The machine code (1)
- The serial number (5)

①				②				③		④		⑤			⑥		⑦	
Ⓐ ~	Ⓑ	Ⓒ	Ⓓ	Ⓔ				Ⓘ	Ⓢ	Ⓣ	Ⓜ	Ⓝ	Ⓔ	Ⓔ	Ⓔ	Ⓔ	Ⓔ	Ⓔ
Ⓐ ~	Ⓑ	Ⓒ	Ⓓ				Ⓟ	Ⓢ	Ⓣ	Ⓜ	Ⓝ	Ⓔ	Ⓔ	Ⓔ	Ⓔ	Ⓔ	Ⓔ	Ⓔ
~			Ⓜ	Ⓩ				Ⓢ	Ⓣ	Ⓜ								

EXTRAORDINARY MAINTENANCE

The information and instructions in this section are reserved for specialised personnel, authorised to operate on the equipment components.

VIDEO BOARD MAINTENANCE CHECKLIST

Turn the mains switch OFF.
Disconnect the plug.

To access the video board and the encoder:

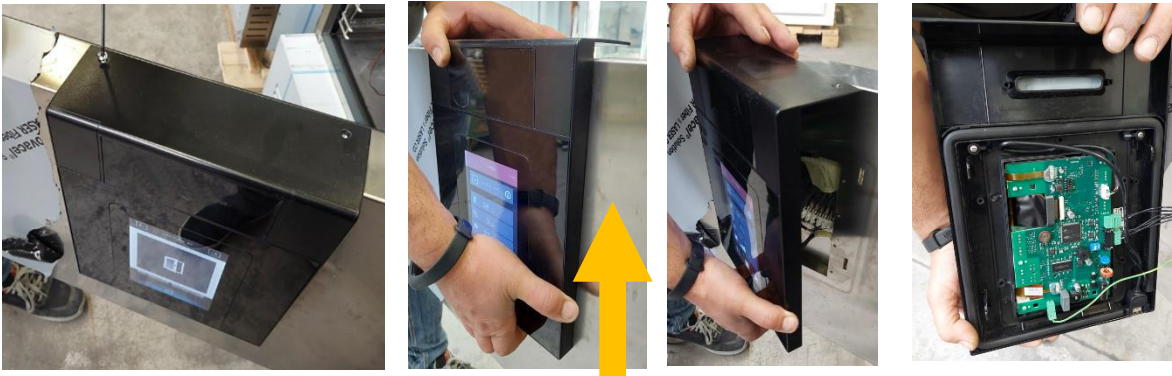

Unscrew the two screws securing the board holder.
Lift up the board holder and remove it from the door.
Take care with the cables.

ATOMISER NOZZLE MAINTENANCE

Turn the mains switch to the OFF position.
Remove plug from socket.

Access the evaporator fan guard:
Unscrew the fan guard fastening screws.
Open the door.

Use open spanners 17 and 18 to disassemble the atomiser nozzle.

Check for impurities and, if necessary, remove them using potable water at mains pressure.

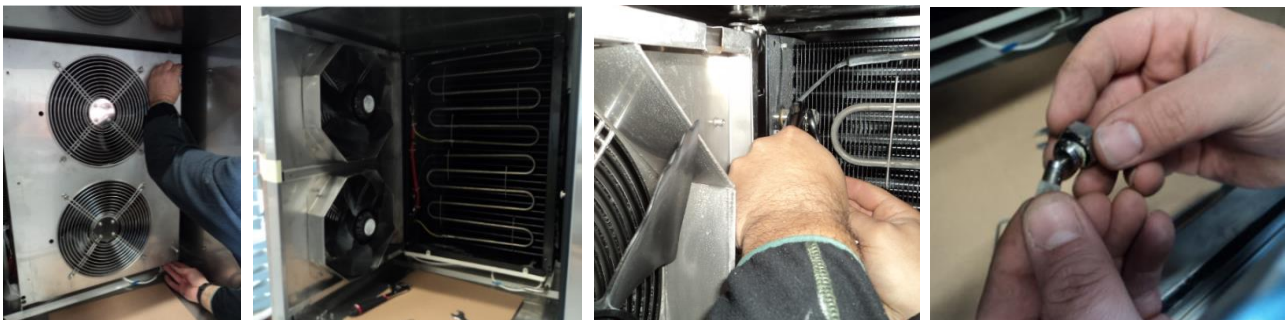
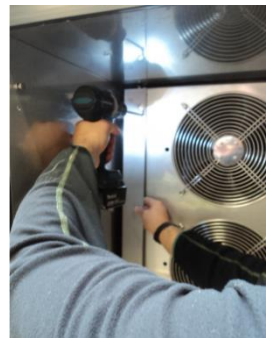

When nozzle maintenance is complete, select settings, water data to reset the number of injections.

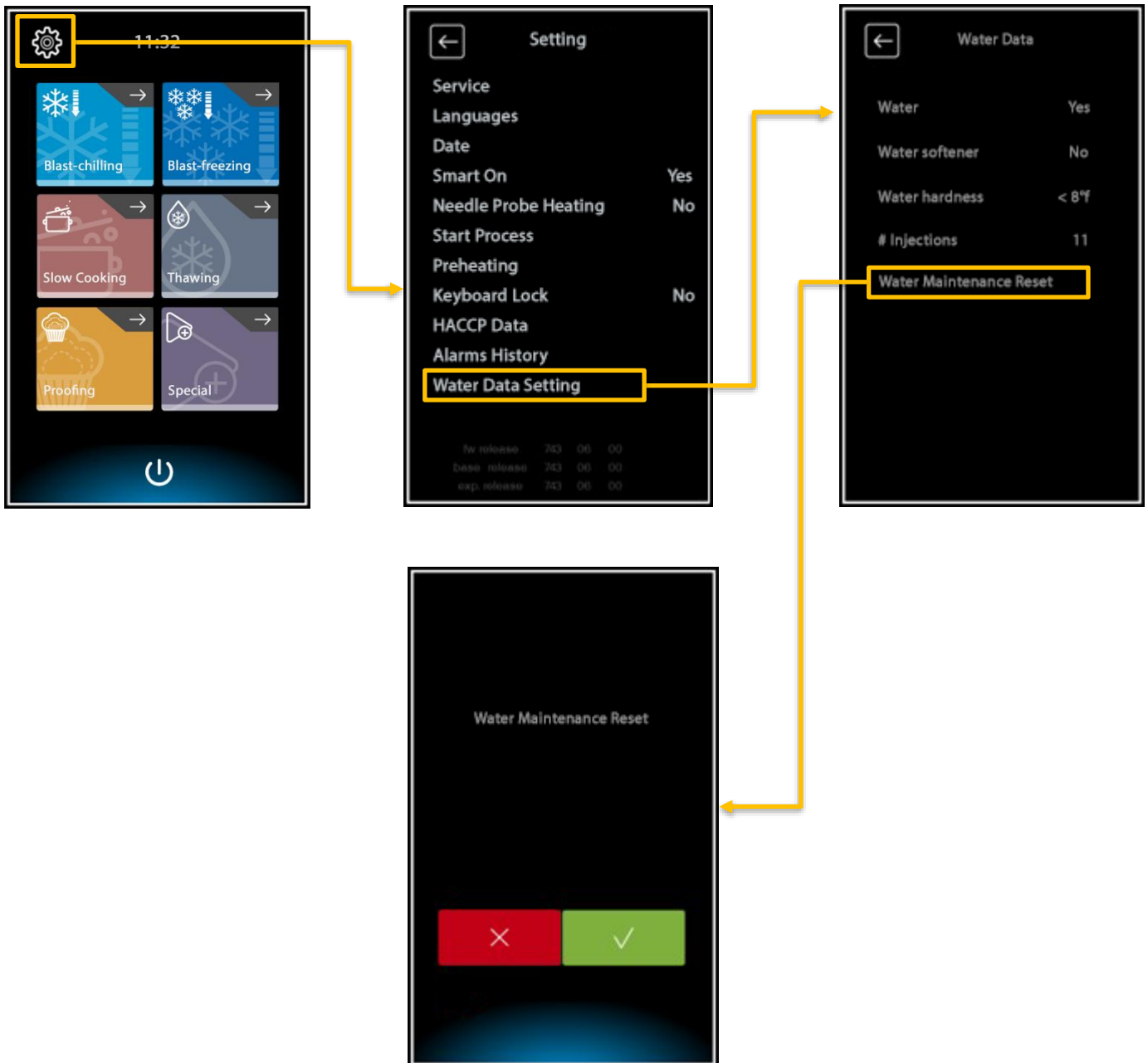

MAINTENANCE OF PANEL BOARD

Turn the mains switch OFF.
Disconnect the plug.

To be able to access the electric picture:

Mod. ...51M

Unhook the front guard, pulling it towards you.



Remove the closing panel screws.
Remove the closing panel.



Remove the electrical panel locking screw.

Move the electrical panel box along the slide.



Mod. ...51H

Remove the side panels by means of the screws.

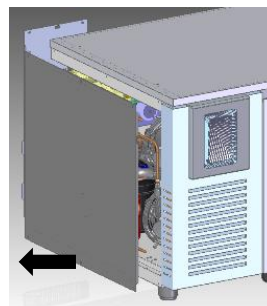

Mod. ...101L – ...101S

Unhook the front guard, pulling it towards you.



Remove the closing panel screws.
Remove the closing panel.



UPDATING THE FIRMWARE (SOFTWARE) OF THE ELECTRONIC CIRCUIT BOARDS

Check the firmware version now present on the unit boards.

- Select SETTINGS.
- Check the firmware version now present on the unit boards.

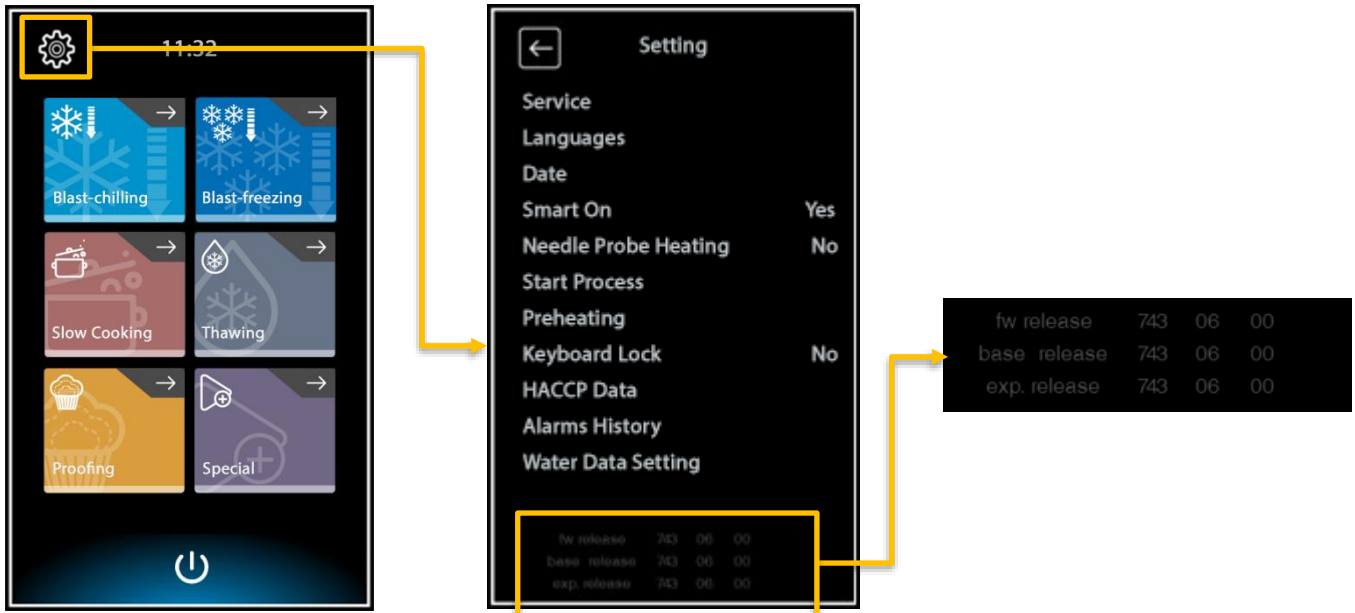

UPDATE PROCEDURE

The procedure should only be performed by specialised personnel.

To update the firmware (software) of the circuit boards, it is necessary to have a pen drive (FAT32 formatting) on which the controller's operating system files are stored (files with the extension `eiml.ucjb` and `work.ucjb`).

Insert the pen drive into the USB port located under the control panel and wait for instructions from the control panel before removing it.

After removal, switch the machine off and on again.

CONDENSING SYSTEM MAINTENANCE

Mod. ...51M – ...101L – ...101S

To access the condensing system, remove the rear protective grille, undoing the screws.



Mod. ...51H

To access the condensing system, remove the side panel, undoing the screws.

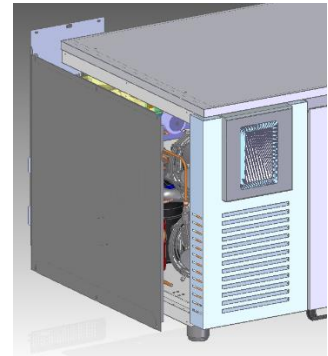

REPLACEMENT CORE PROBE

Turn the connector anti-clockwise, completely unscrewing it so as to disconnect the core probe cable.



Replace the core probe, screwing the connector completely back in.
Take care when inserting the connector so that all contact pins are perfectly aligned with those on the fixed connector attached to the door. Failure to do so may lead to probe breakage.



FURTHER INFORMATION

ERGONOMIC FEATURES

CERTIFICATION

The ergonomic characteristics of the product, which can influence the physical and cognitive interaction the user has with it, have been assessed and certified.

In fact, a product with ergonomic features meets specific ergonomic requirements belonging to three different areas:

polytechnical, biomedical and psychosocial (usability and satisfaction).

Tests were carried out with real users for each of these areas. The product was then found to comply with the ergonomic acceptability criteria set out in the standard.

GENERAL RECOMMENDATIONS

The blast-chiller has been designed and tested to minimise physical problems associated with product interaction.

Loading and unloading trays and interacting with the product can lead to incorrect postures and the handling of heavy weights, areas of your daily activity that we have tried to alleviate.

In any case, we would like to suggest some operational procedures to adopt:

- Handle the tray in a balanced manner, trying not to bend your back when loading/unloading.
- If possible, bend your legs and do not bend your back forward when placing the trays in the lower shelves and while trying to reach tools or objects placed below.
- Whenever possible, try to position the trays in the cabinets with their weight in mind, as suggested by the attached images.
- If possible, push and pull the tray trolley to reduce distances.
- Maintaining viewing distance to understand the information shown on the display or to view the object in the cabinet, reducing the time spent with eyes facing upwards (neck extension) as much as possible.

RECOMMENDED HANDLING OF TRAYS ACCORDING TO THEIR WEIGHT

Try to position the trays in the cabinets with their weight as suggested by the images below.

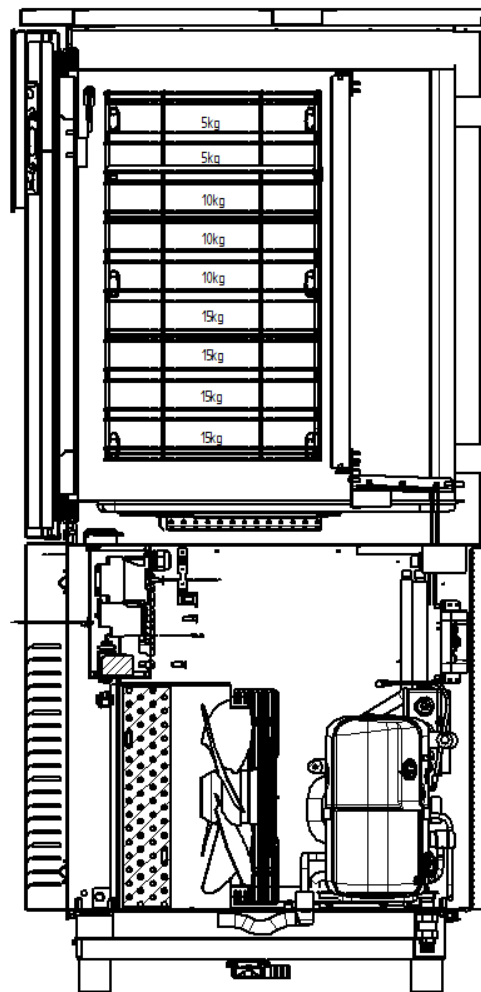
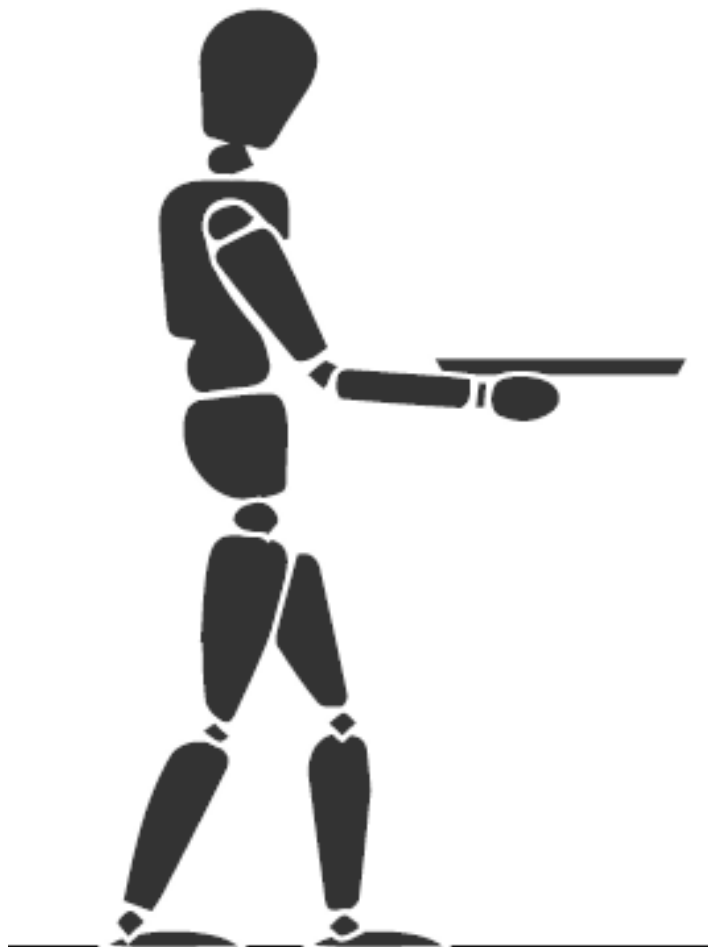
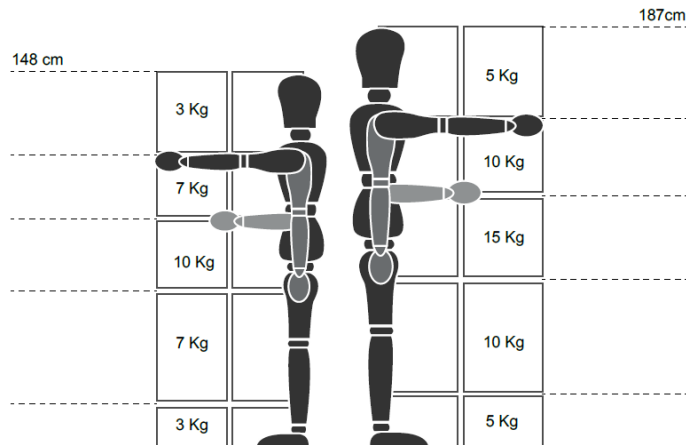

ENERGY CONSUMPTION CHART (*)

tab 1

Modello - Model		...51H	...51M	...101L ...101S	
Tipo di prodotto – Type of product		Abbattitore/surgelatore Blast chiller and freezer			
Refrigerating fluid		R452A			
GWP		2141			
Refrigerant load [kg]		0.8	1	1.5	
Program used for the blast-chilling process		Hard Blast-chilling			
Program used for the freezing process		Hard Freezing			
Description	Symbol	Value			Unit
Blast-chilling energy consumption	E	0.09	0.09	0.09	kwh/kg
Blast-chilling cycle mass		20	25	50	Kg
Freezing energy consumption	E	0.299	0.28	0.268	kwh/kg
Freezing cycle mass		10	15	30	kg
Refrigerant load		0.8	1	1.5	kg
Ambient operating temperature		30	30	30	°C
Blast-chilling cycle from 65°C to +10°C	t	120			min
Freezing cycle from 65°C to -18°C	t	270			min
Contact details	Angelo PO Grandi Cucine spa a sole-shareholder company				

(tab 12)

(*) EN ISO 22042:2021

WIRING DIAGRAM PLATE

The electrical diagram is shown on the last page of the booklet.

No.	DESCRIPTION	No.	DESCRIPTION
1	COMPRESSOR	73	FUSE-HOLDER WITH UNIPOLAR FUSE
2	CONDENSER FAN	75	LIQUID LINE SOLENOID VALVE
2A	THERMOSTATED CONDENSER FAN	76	MAGNETIC MICRO-SVWITCH
3	GENERAL TERMINAL BOARD	77	COMPARTMENT PROBE
3A	GENERAL TERMINAL BOARD	78	EVAP./DEFROST PROBE
3B	GENERAL TERMINAL BOARD	79A	MULTIPOINT NEEDLE CORE PROBE
9	EVAPORATOR FUN	79B	MULTIPOINT PROBE RESISTANCE
12	DEFROST SOLENOID VALVE	80	PTC RESISTANCE FOR COMPRESSOR CASING
20	DOOR ANTICONDENSING RESISTOR	86	CONDENSER PROBE
22	WATER DRAIN PAN HEATING ELEMENT	87	LCD QUICK COOLER CARD
25	NEEDLE PROBE HEATING TRANSFORMER	91	CONDENSATION EVACUATION PTC HEATING ELEMENT
25A	TFT BOARD POWER TRANSFORMER	97A	EVAP. FAN PARTIALISER MODULE
65	CONTACTOR	102	BIMETALLIC SAFETY THERMOSTAT
66	THERMAL RELAY	103	HUMIDITY PROBE
67	EVAPORATOR FAN RUN CAPACITOR	107	COMPARTMENT HEATING ELEMENT
67A	EVAPORATOR FAN RUN CAPACITOR	107B	COMPARTMENT B HEATING ELEMENT
69	GROUNDING TERMINAL	112	HUMIDIFIER WATER SOLENOID VALVE
70	HIGH PRESSURE PRESSOSTAT	134	HOT CYCLE FUNCTIONS MODULE
70B	CONDENSATION PRESSURE SWITCH	135	WATER DRAIN SOLENOID VALVE
71	POWER PANEL ELECTRONIC CARD	140	LIQUID SOLENOID VALVE EMI FILTER
72	TFT CIRCUIT BOARD	140A	DEFROST SOLENOID VALVE EMI FILTER